



Livestock Intelligence™

RESOURCE GUIDE





Livestock Intelligence™ Index

1-3	Cattle Tags (2 Piece Tags)	18-19	Applicators & Accessories
4-7	Swine and Multi-Species Tags	20-25	Destron Fearing
8	Sheep Mini Tag	26-27	Handheld EID Readers
9	ATag™ Cow and Calf (1 Piece Tags)	28-29	Antennas
10	Official Tags	30	Managing EID Data
11	Custom ID	31	Software
12	Allflex Feedlot Tags	32-34	Tissue Sampling Technology
13	ATag™ Feedlot	35	Tag Marking Pens
14	Advantage Feedlot Tags	36-37	Monitoring
15	Custom Feedlot Tags	38-49	Syringes
16	Electronic ID	50	EID Tag Placement
17	Matched Pair Sets	53	EID Tag/TSU Lookup

Get The Allflex Advantage

Allflex has more experience in livestock identification than any other manufacturer and we're committed to helping people with high quality products needed in the livestock industry. For products that exceed industry standards for performance, you can rely on Allflex. As an Allflex customer, you'll benefit from a proven track record for innovation, new products and unparalleled product delivery and service.

Innovation: From pioneering electronic identification systems and creating the first custom, laser Ink, marked visual identification tag, to leading the industry in tamperproof tags, to laser-ink marking, Tissue Sampling Units and animal health monitoring, we're dedicated to finding new and better products for the market we serve.

New Products: We consistently introduce new and improved products based on sound manufacturing and an understanding of how those products need to perform in real-world conditions.

Service: Count on Allflex's professional field sales, customer service and technical staff who will help identify the right solution for specific operations and share best practices to achieve the maximum in product performance. You can count on reliable supply and delivery ... which means producers will have the tags and equipment when they need it.

For questions about these products or how to get started, contact Allflex at 1-800-989-TAGS (8247) or visit www.allflex.global/na



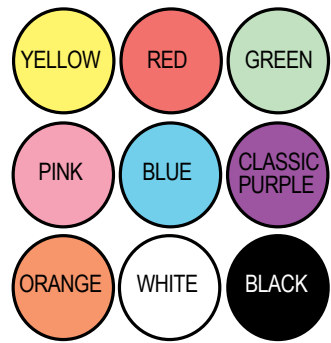

Allflex Global Tags are packaged standard in sets of 25 – blank or numbered sequentially. Other tag combinations are available upon request.

BLACK tags available in Super Maxi, Maxi and Large Female only. Black tags are laser marked with white characters.

CLASSIC PURPLE available in Maxi and Large Female only.

Global Super Maxi Female

- Used primarily for mature cattle
- Laser-ink management number standard
- Largest panel for management information
- Highly visible from both front and back
- Especially useful in cold climates for animals with longer hair
- Packaged with Global Small Male



Global Super Maxi Female
Size: 4 5/8" high x 3" wide

SKU: GSXF/GSM

Global Maxi Female

- Our most popular size for both mature cattle and calves
- Laser-ink management number standard
- Excellent for beef and dairy cattle
- Packaged with Global Small Male

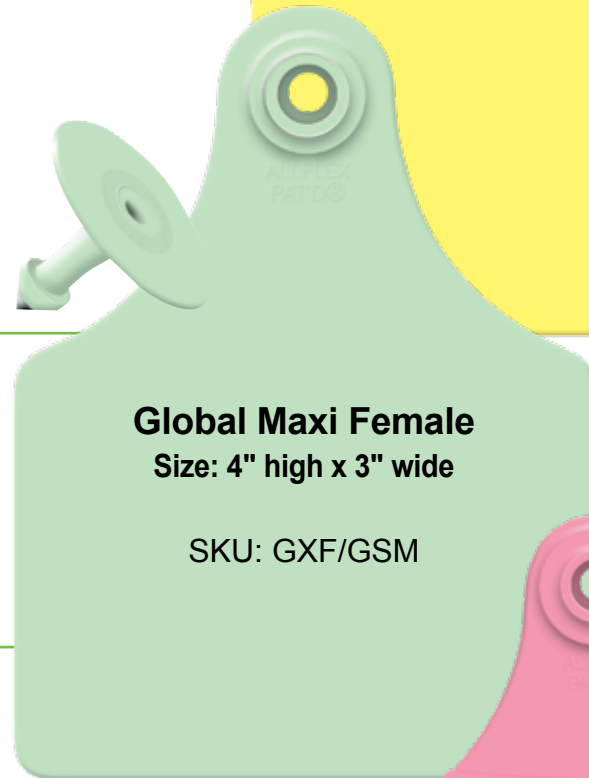

Global Maxi Female
Size: 4" high x 3" wide

SKU: GXF/GSM

Global Large Female

- Used primarily for calves
- Laser-ink management number standard
- For use in beef and dairy cattle
- Packaged with Global Small Male

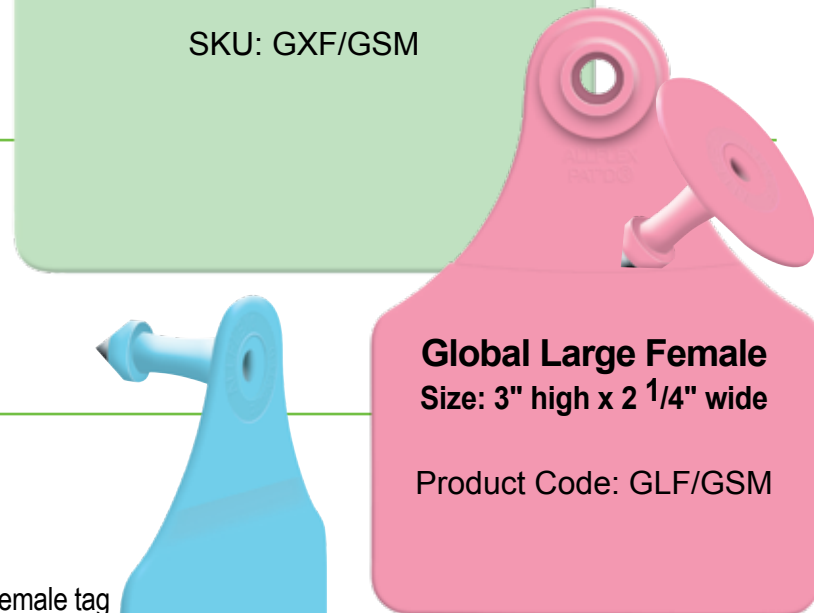

Global Large Female
Size: 3" high x 2 1/4" wide

Product Code: GLF/GSM

Global Large Male

- Best used for beef and dairy cattle
- Provides visibility from behind an animal
- Can be used in combination with any Allflex Global Female tag
- Packaged without female tags (quantities of 25)



Global Large Male
Size: 2 3/4" high x 2 1/4" wide
SKU: GLM



Patented Allflex Tamperproof™ ear tags offer the foremost security in livestock identification and management.

- Tamperproof™ tags are ideal for Official Registration and Certification Programs, as well as Official ID Markets
- Allflex Tamperproof™ Female tags feature either the exclusive Ultra Cap™ or the Rotaclip™ design
- Can be used in combination with any Allflex male tag
- Packaged standard with Global Small Male



Tamperproof™ Maxi Female (Ultra Cap™)

Size: 4" high x 3" wide

Product Code: GTXF/GSM



Tamperproof™ Large Female (Ultra Cap™)

Size: 3" high x 2 1/4" wide

Product Code: GTLF/GSM



Tamper-evident Small Female (Rotaclip™)

Size: 1 3/16" diameter

SKU: GSTF

Allflex's Exclusive Ultra Cap™

Tamperproof™ Maxi Female and Tamperproof™ Large Female

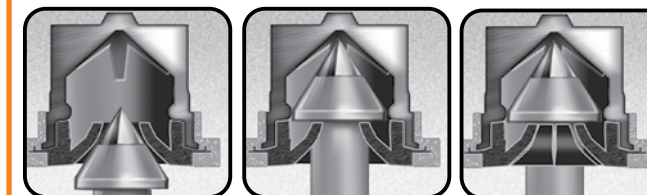

1

On entry into female, the male tip forces the exclusive Ultra Cap™ to spring open inside.

2

When tip has fully entered, Ultra Cap™ snaps back to lock tag solidly in place.

3

Ultra Cap's™ hard ridge and female's molded ridge doubly secure tag. Ultra Cap™ allows female to turn on male stem to help prevent snagging.

Allflex's Exclusive Rotaclip™

Tamperproof™ Small Female

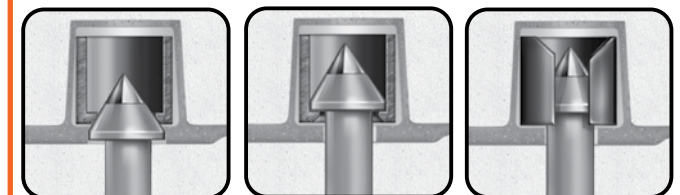

1

On entry into female, the male tip forces the exclusive Rotaclip™ to spring open inside.

2

When tip has fully entered, Rotaclip™ snaps back to lock tag solidly in place.

3

Rotaclip's™ hard ridge and female's molded ridge doubly secure tag. Rotaclip™ allows female to turn on male stem to help prevent snagging.

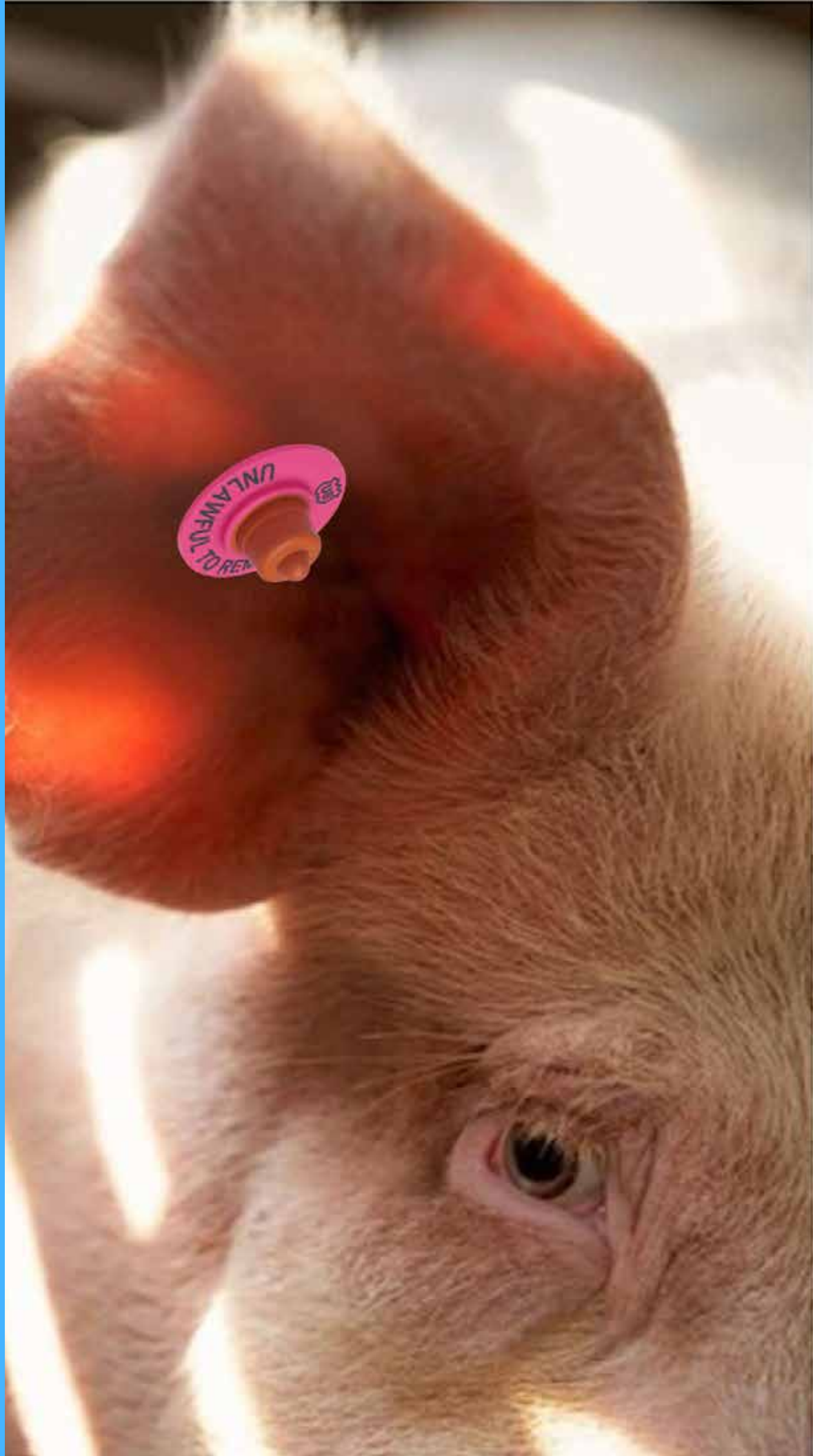

Piglet Tag *LASER MARKING ONLY*

- Light weight tag and unique metal-free tip – specifically designed for piglets from birth to 40 lbs.
- Enhanced plastics minimize the effects of biting and chewing
- Designed to avoid over-application and infection problems
- Durable laser marking

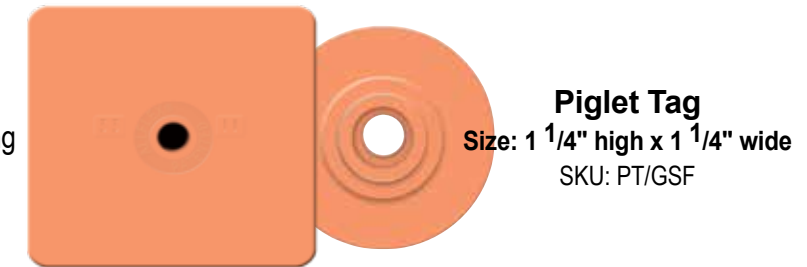

Integra™ Hog Male

- Large panel holds more management information
- Longer male stem allows for higher tag placement in ear
- Lays flat to resist snagging and chewing
- Laser-ink available on management numbers larger than 1/2"
- Used in combination with Global Small Female and Tamperproof™ Small Female tags

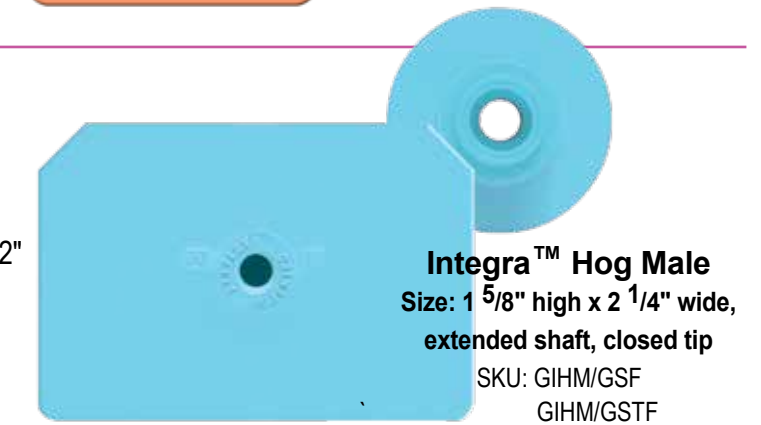

Global Hog Male

- Longer male stem allows for higher tag placement in ear
- Lays flat to resist snagging and chewing
- Laser-ink available on management numbers larger than 1/2"
- Used in combination with Global Small Female and Tamperproof™ Small Female tags



Official USDA Swine Premises Tags

- Tags must be applied prior to harvest channel entry
- Tags must have premises ID number and shield
- Cull sows and boars required to have PIN tag
- PIN of last farm required
- Additional colors now available

Size: 1 5/8" high x 2 1/4" wide, extended shaft, closed tip
SKU: USDA-GIHM1/GSTF-COLOR





Global Sheep Female



Global Sheep Male

Size: 2" high x 5/8" wide
 Male Size: 2" high x 5/8" wide
 SKU: GPF/GPM

Global Sheep Female and Global Sheep Male

LASER MARKING ONLY

- Provides good visibility without weighing ear down
- Global Sheep Female and Global Sheep Male packaged standard in sets of 25 – blank or numbered sequentially
- In numbered sets, both male and female are laser marked
- Available in yellow, red, green, pink, blue, orange and white (not available in purple or magenta)

Global Sheep Tag Colors

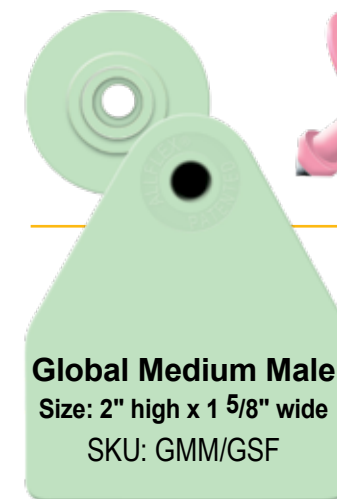
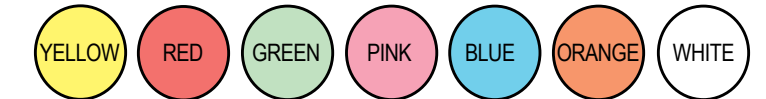

Global Medium Male
 Size: 2" high x 1 5/8" wide
 SKU: GMM/GSF

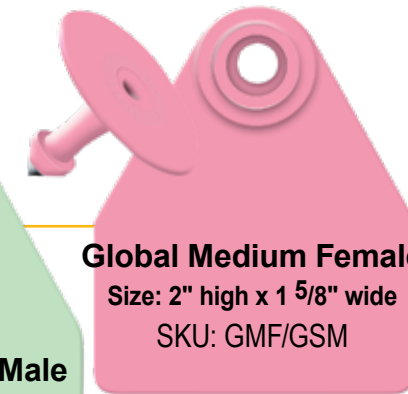

Global Medium Female
 Size: 2" high x 1 5/8" wide
 SKU: GMF/GSM

Global Medium Female

- Used for calves, hogs, goats and sheep
- Laser-ink available on management numbers larger than 1/2"
- Packaged standard with Global Small Male

Global Medium Male

- Packaged standard with Global Small Female
- Laser-ink available on management numbers larger than 1/2"
- Also available blank in packages of 25 without female companion



Global Small Male

Size: 1 3/16" diameter
 SKU: GSM (Shaft length 22.3mm, Tip Color: Black)
 GESM (Shaft Length: 25.3mm, Tip Color: Silver)

Global Small Male

LASER MARKING ONLY

- Self-piercing tip
- Engineered for superior retention
- Numbered Global Small Male packaged standard with blank Global Small Female
- Also available with extended shaft for thicker ears
- Available blank in packages of 25 without female companion



Global Small Female & Tamperproof™ Small Female tags

Size: 1 3/16" diameter SKU: GSF

Global Small Female & Tamperproof™ Small Female tags

LASER MARKING ONLY

- Blank Global Small Female or Tamperproof™ Small Female packaged standard with Global Small Male, Medium Male, Hog Male, Integra Hog Male and Piglet tags
- Also available blank in packages of 25 without male companion

Global Medium and Global Small Female Tag & Small Female Tamperproof™ Colors

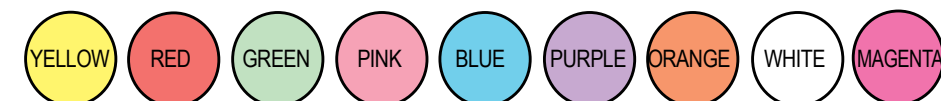

Sheep Mini

LASER MARKING ONLY

- Light weight and flexible enough for the smallest goat kids and lambs
- Easy to apply, utilizes Allflex Universal Total Tagger
- Durable laser mark
- Used In Official Livestock Programs including the USDA Scrapie Eradication Program
- Packaged in bags of 20

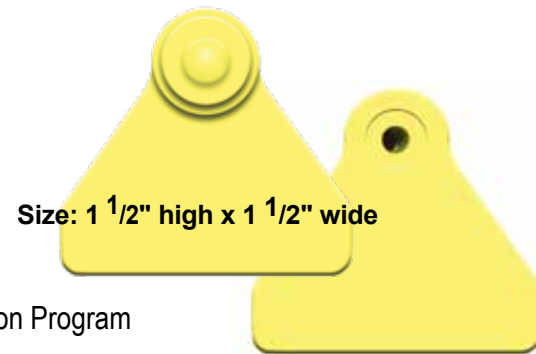

Size: 1 1/2" high x 1 1/2" wide

SKU: SMF/SMM

Tag Colors:

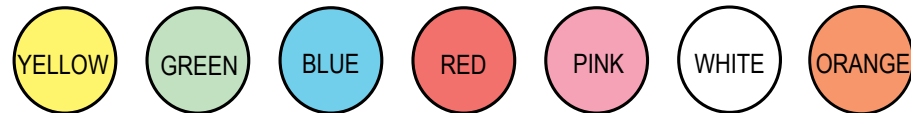

Tag Application for Two-Piece Tags

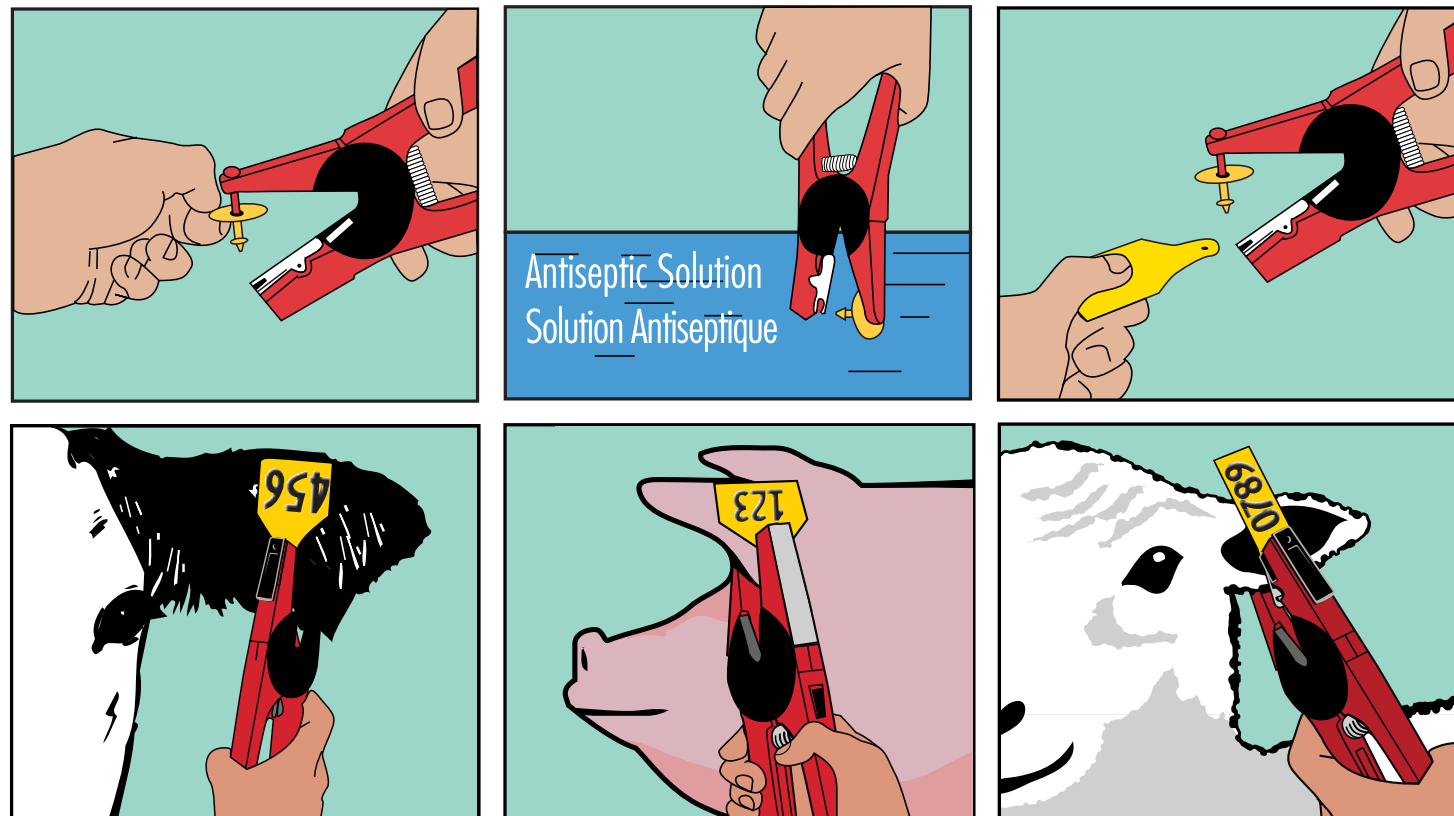

Antiseptic Solution
Solution Antiseptique

A Tag™ One-Piece Tag

- Quality materials and construction in new, one-piece tag
- Two convenient sizes
- Patented laser-ink permanent marking
- Custom marking and numbering available by special order
- Easy one-piece application
- Self-piercing, pinhole tip means faster healing, reduced animal stress
- Black ATags are laser marked with white characters

One-Piece Self-Piercing Tip



COW
4 1/2" high x 3" wide
SKU: ATAGX

CALF
3.875" high x 2.5" wide
SKU: ATAGL

Cow/Calf Tag Colors:

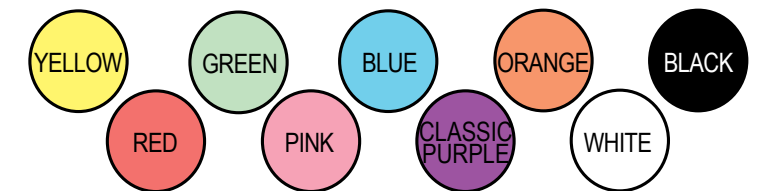

A Tag™ One-Piece Applicator

- To be used exclusively with ATags™



SKU: APP-ATAG

A Tag™ Replacement Pin

SKU: PIN-ATAG





Large FDx

SKU: USDA-FDX840/GTLF1-GSM-COLOR



Maxi HDx

SKU: USDA-HDX840/GTXF1-GSM-COLOR



All-in-One FDx

SKU: USDA840FDXAIO1-Y/GESM-Y



Animal Disease Traceability System AIN Tags

The ADT program is a cooperative Federal-State-Industry Program, providing a standardized information system for Federal and State animal-health authorities to use in responding to animal-disease events in the United States. These tags all start with the numbers 840 which is the global standard for US origin animals. Individual EID tags or tag sets can include coding protocol.

In order to obtain AIN tags, producers must first register their premises and obtain a premises identification number (PIN) from their state animal health authority. A database record of specific AIN tags distributed to each premises is maintained, so producers should not share or make their AIN tags available to other producers.

Producers may apply the AIN tags at their convenience and at the time most suitable to their operation, but before an animal leaves their premises.



ATag™ Cow HDx

SKU: HDX-840/ATAGX-COLOR-SET16

NEW! TAG SELECTOR IS HERE!

Visit: <https://tagselector.allflexusa.com/>



Allflex Custom ID is the Producer's Choice

- Your livestock management program may benefit from Allflex Custom ID
- Allflex offers permanent, customizable markings on premium quality 2-Piece Global, Tamperproof™ and ATag™ One-Piece tags with Laser and Laser-Ink Marking
- There are multiple customization options available giving you the flexibility to create something as simple or complex as you need
- Tag colors and marking options will vary depending on tag selection

Customize Your Information

- Producers can use a variety of information fields available on different tags to truly customize their identification
- Use identification to measure what matters on your livestock operation
- Custom ID tags can include:
 - Brands and other images
 - Combinations of letters and numbers including farm or ranch name and location
 - Reverse side markings on the back of the tag
 - Custom numbering that's tailored to your management program
 - Birth dates and years
 - Sire and dam information

Premium Black Tags

- Allflex Producer's Choice Custom ID™ includes premium black ear tags in three Global Tag sizes: Super Maxi Female, Maxi Female and Large Female
- The premium black tags feature permanent white Allflex laser marking
- Black Allflex Global Small Male Tags are available blank as a matching companion or to contrast with other Allflex Global Tag colors

Premise Number or LID is required to purchase 840 tags, these can be obtained from your State Department of Ag.

Visit www.allflex.global/na to find an online distributor.



Allflex Feedlot Tag
Size: 4 1/4" high x 3" wide
SKU: FL

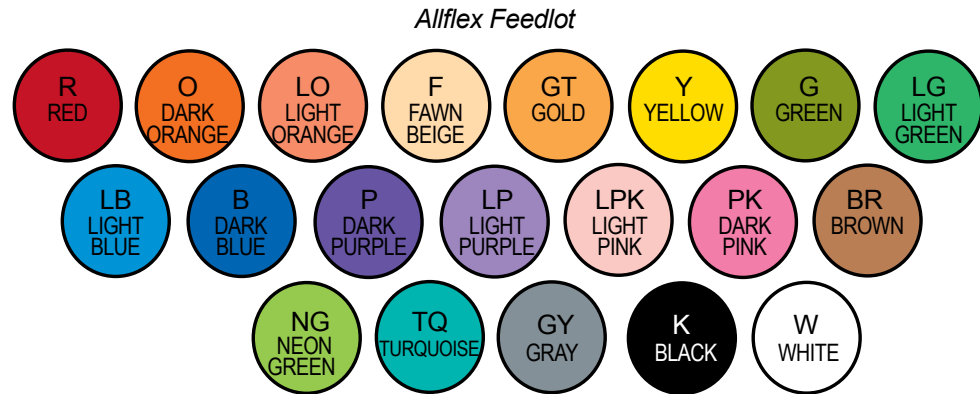

Allflex Feedlot Tags are stocked in packages of 50 blank tags. Lot numbering, sequential numbering and custom marking are available by special order.

Allflex Feedlot Tag

- One-piece tag engineered for retention and readability
- Small oval incision of Allflex Feedlot Tag results in quicker healing
- Large panel for multiple lines of information and custom marking
- Apply with Allflex Feedlot Applicator (Manual or Air)



Manual Allflex Feedlot Tag Applicator

- Easy to use for safe feedlot tag application
- Replacement anvil and pin available
- To be used exclusively with Allflex Feedlot Tags

Allflex Feedlot Tag Applicator

SKU: APP-FL

Replacement Pin

SKU: PIN-FL

Anvil

SKU: APP-FL-ANVIL



Compressed Air Allflex Feedlot Tag Applicator

For lease terms, contact your local Allflex distributor or Allflex regional manager

Compressed Air Allflex Feedlot Tag Applicator

- Designed for volume tagging
- Easy to use for safe feedlot tag application
- Replacement pin available
- Available for lease to Allflex feedlot customers
- To be used exclusively with Allflex Feedlot Tags

SKU: APP-FL-AIR *LEASED PRODUCT



ATag™ Feedlot Tag
Size: 4 1/2" high x 3" wide
SKU: ATAGF

ATag™ Feedlot Tag

- Self-piercing, pinhole tip means faster healing, reducing animal stress
- Easy one-piece application
- Small incision results in quicker healing
- Apply with Allflex One-Piece Applicator

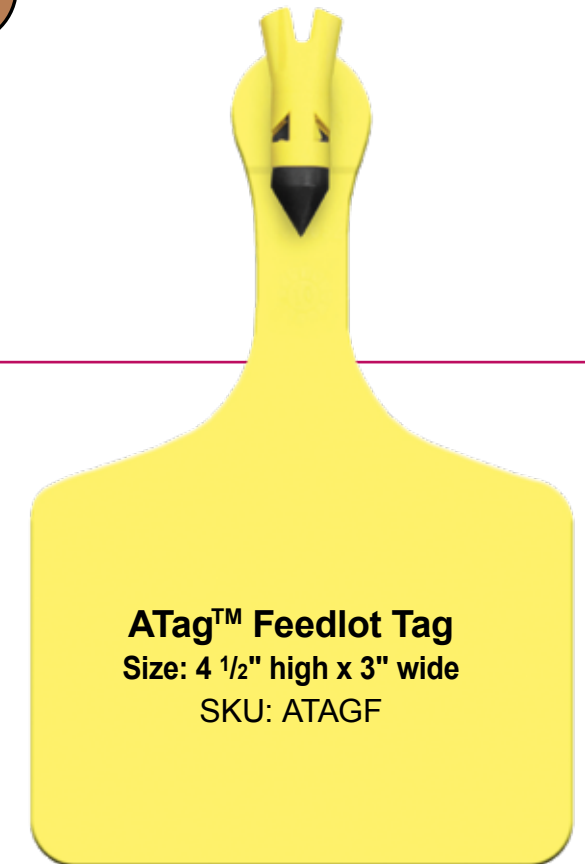

ATag™ Feedlot Tag
Size: 4 1/2" high x 3" wide
SKU: ATAGF

ATag™ One-Piece Applicator

- For use with ATag™ One-Piece Tag
- Deep jaw makes proper placement easier
- Grip is designed to ease hand fatigue from repeated use
- Replacement applicator pin located in handle



ATag™ One-Piece Applicator
SKU: APP-ATAG

ATAG™ Replacement Pin
SKU: PIN-ATAG

Advantage and Maxi Advantage Feedlot Tag Colors



Advantage Feedlot Tag
Size: 4 3/4" high x 2 3/4" wide
SKU: AF

Advantage Feedlot

- Unique shape with more panel space for marking
- Engineered neck and shoulder to reduce twisting
- Advanced pliable material for longevity and easy stamping
- Custom marking and on-site hot stamping options
- Fast application with the Allflex Easy Applicator Knife

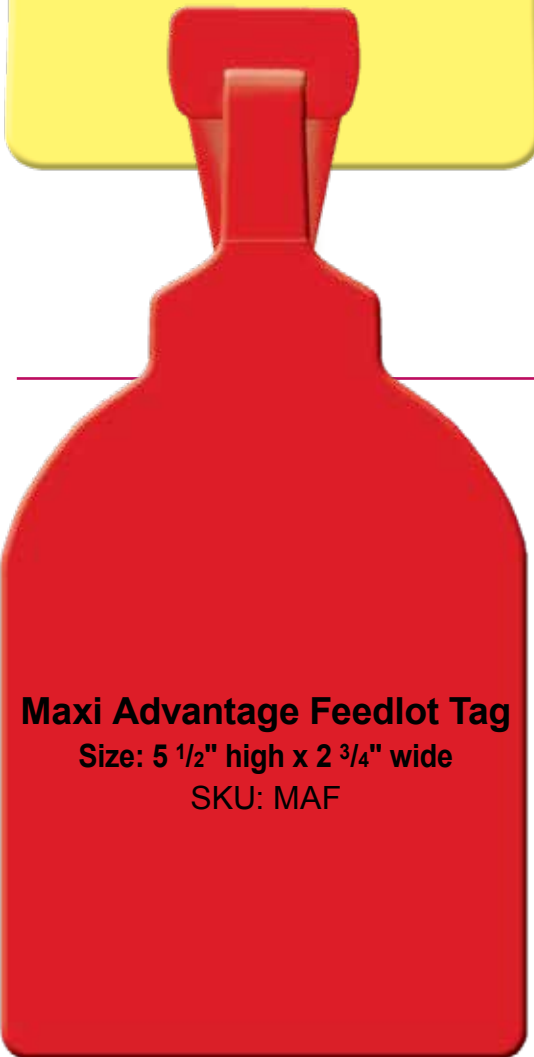

Maxi Advantage Feedlot Tag
Size: 5 1/2" high x 2 3/4" wide
SKU: MAF

Maxi Advantage Feedlot

- Unique shape with extra large panel space for marking
- Engineered neck and shoulder to reduce twisting
- Advanced pliable material for longevity and easy stamping
- Custom marking and on-site hot stamping options
- Fast application with the Allflex Easy Applicator Knife

Allflex Tag Knife

- To be used exclusively with the Advantage and Maxi Advantage Feedlot Tags
- Grip design allows for speedy tag application
- Stainless steel heat treated blade



Allflex Easy Applicator Knife
SKU: APP-FL-KNIFE



FL2
SKU: FL2-COLOR



FL19
SKU: FL19-COLOR



AF1
SKU: AF1-COLOR
Factory printed numbers are high resolution ink only.



MAF8
SKU: MAF8-COLOR

Additional customization can be stamped at feed yard using Allflex Hot Stamp Press.



Additional Custom Layouts Available



Allflex Hot Stamp Press

- Digital tag counter
- Stamps all types of Allflex Feeder tags
- Smaller, more compact
- Digital controls for temperature dwell time
- Controls are separate from the press
- **Available by lease only**

FOIL:
SKU: PP29000
3"wide by 500" long



High Performance Half Duplex HDX Ultra EID Tag

- HDX technology optimizes signal transmission and provides greatest possible read distance
- Tamperproof Ultra Cap™ provides ultimate security and retention
- ISO Compliant
- HDX Tag weight: 8 grams
- Packaged in quantities of 10, 20, 25, 50, 250 and 1000



Standard Performance Full Duplex FDX EID Tag

- FDX technology
- Tamperproof Ultra Cap™ provides ultimate security and retention
- ISO Compliant
- FDX Tag weight: 9 grams
- Packaged in quantities of 20, 25, 50, 250 and 1000



Lightweight FDX EID

Standard Performance Full Duplex FDX Lightweight EID Tag

- FDX technology
- ISO compliant
- FDX Lightweight tag weight: 4 grams
- Packaged in quantities of 20, 50 and 250



Standard Performance Full Duplex FDX B80 EID Tag

- FDX technology
- ISO compliant
- FDX Lightweight tag weight: 3.5 grams
- Packaged in quantities of 20
- Non-Tamperproof™



HDX Reusable EID Tag, Extended Small Male

HDX Reusable High Performance EID Tag

- HDX Technology
- ISO Compliant
- HDX Reusable Tag weight: 8 grams
- Packaged in 20, 25, 250 & 1,000



FDX Reusable Standard Performance EID Tag, Extended Small Male

FDX Reusable High Performance EID Tag

- FDX Technology
- ISO Compliant
- FDX Reusable Tag weight: 9 grams
- Packaged in 20, 25, 250 & 1,000



HDX-Maxi Matched Set 28

SKU: HDXOTP982/GTXF-COLOR-SET28

EID Visual Matched Sets

- Sets are available in combinations of HDX or FDX EID tags paired with Maxi or Large Visual tags (other visual tag combinations available)
- All tags have corresponding Laser-Ink printed numbering
- Both tags feature the Tamperproof Ultra Cap™
- Tamperproof™ Maxi Tag size: 4" high x 3" wide
- Tamperproof™ Large Tag size: 3" high x 2 1/4" wide

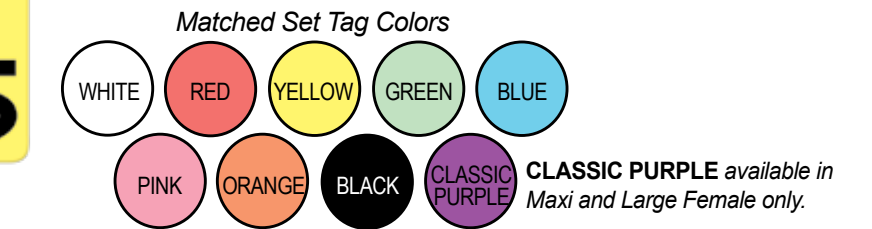

FDX-Maxi Matched Set 18

SKU: FDXOTP982/GTXF-COLOR-SET18



HDX-Maxi Matched Set 17

SKU: HDXOTP982/GTXF-COLOR-SET17



HDX-Large Matched Set 3

SKU: HDXOTP982/GTLF-COLOR-SET3



Allflex All-in-One Maxi Tag

SKU: AIOX



Allflex All-in-One Large Tag

SKU: AIOL

Allflex All-in-One

- Available in HDX (Half Duplex) and FDX (Full Duplex)
- Combines Allflex Maxi or Large visual tag with EID component
- Tamperproof Ultra Cap™ provides ultimate security and retention
- ISO Compliant
- All-in-One Tag comes in Maxi and Large sizes
- All-in-One Tag weights: HDX Maxi 17.0 grams, HDX Large 12 grams, FDX Maxi 18 grams, FDX Large 13 grams
- Two colors available: White (HDX only) and Yellow (FDX only)



Universal Total Tagger
SKU: APP-UTT

Universal Total Tagger

- A must for applying Allflex 2-Piece Global Tags
- Also use to apply Allflex Tamperproof™ and EID Tags and most major brands of Insecticide Tags
- Deep jaw makes proper placement easier
- Grip is designed to ease hand fatigue from repeated use
- Replacement applicator pin located in handle
- Black Clip Included

Remove Black Insert for EID Application



Universal Total Tagger Black Insert
SKU: CLIP-UTT-K

Universal Total Tagger Black Insert

- For use in Universal Total Taggers (Red and Green)
- Use to apply Allflex Global and Tamperproof™ Tags



Universal Total Tagger Pin (Red Blunt)
SKU: PIN-UTT

Universal Total Tagger Pin (Red Blunt)

- For use in the Universal Total Tagger (Red)
- Use to apply Allflex Global, Tamperproof™ and EID Tags
- Can also be used with Global Retract-O-Matic™



Universal Total Tagger Pin (Blue Blunt)
SKU: PIN-PT

Universal Total Tagger Pin (Blue Blunt)

- For use in the Universal Total Tagger (Red)
- Use to apply Allflex Piglet Tags

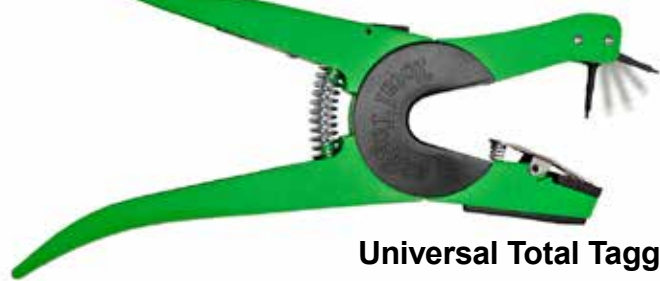

Universal Total Tagger +
SKU: APP-UTT-PLUS

Universal Total Tagger + (with flip-pin feature)

- If animal pulls away during application the pin will flip forward
- Will apply all varieties of Allflex 2-Piece Global Tags
- Deep jaw makes proper placement easier
- Grip is designed to ease and fatigue from repeated use
- Replacement applicator pin located in handle



Universal Total Tagger+ Pin (Black Blunt)
SKU: PIN-UTT-PLUS

Universal Total Tagger+ Pin (Black Blunt)

- For use in the Universal Total Tagger+ (Green)
- Use to apply Allflex Global, Tamperproof™ and EID Tags

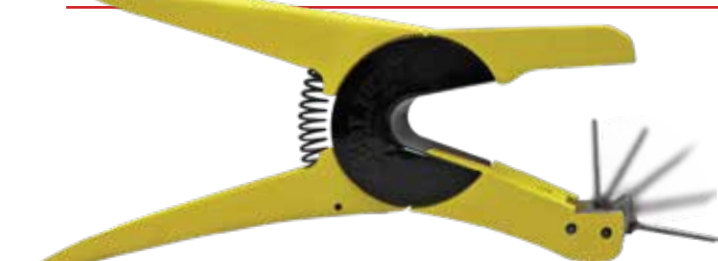

Allflex One-Piece Applicator
SKU: APP-ATAG

ATag™ One-Piece Applicator

- For use with ATag™ One-Piece Tag
- Deep jaw makes proper placement easier
- Grip is designed to ease hand fatigue from repeated use
- Replacement applicator pin located in handle



Allflex One-Piece Applicator Pin (Black Smooth)
SKU: PIN-ATAG

ATag™ One-Piece Applicator Pin (Black Smooth)

- For use in the ATag™ One-Piece Applicator
- Use to apply ATag™ One-Piece Tag



Global Retract-O-Matic™
SKU: APP-RET-GLOBAL

Global Retract-O-Matic™

- Retracts the pin out of the ear before the animal can react
- Automatic applicator
- Contoured pistol grip handle
- Excellent for tagging calves, sheep and goats
- Packaged complete with loaded red blunt pin and replacement pin
- Anvil can be positioned at any angle



EID Ultra Retract-O-Matic™
SKU: APP-RET-ULTRA

EID Ultra Retract-O-Matic™

- Applies High Performance (HDX) and Standard Performance (FDX) EID tags
- Retracts the pin out of the ear before the animal can react
- Contoured pistol grip handle
- Anvil can be positioned at any angle
- Uses red blunt pin
- Automatic applicator

Ultra Replacement Kit
SKU: EID-ANVIL-KIT
Ultra Anvil
SKU: APP-RET-HANV

Ultra Retract-O-Matic™ Replacement Parts

Kit Includes:

- Shaft
- Base
- 2 Springs
- Nut & Pin



Allflex Safety Ear Tag Removal Tool
SKU: KNIFE

Allflex Safety Ear Tag Removal Tool

- Hook blade design slips easily between base of male tag and animal's ear
- Safety hook design makes tool safe for both livestock producer and animal



SKU: PIN-RET-DF

DF ROM Pin

With the new specialty DF ROM Pin (Anodized Yellow), Destron Fearing tag customers can utilize the Allflex™ Retract-O-Matic™ for applying both Destron Visual and Electronic (EID) tags. The Allflex ROM's will ship with the standard Allflex Red Pin. The Destron ROM Pin is an accessory item that should be ordered separately to replace the Red Pin.



Allflex added Destron Fearing™ to our product line in 2012 to diversify our business with a proven brand and product. Look for Destron Fearing products at your local animal health store, distributor, catalog, online retailer or veterinarian.

Identify. Profit.

In 1945 Destron Fearing™ created the country's first commercially marketed visual identification tags for livestock. This is the foundation of today's animal identification solutions for producers worldwide.

Destron Fearing™ continues its tradition of leadership by manufacturing a range of innovative visual and electronic identification products, helping livestock producers reliably identify their animals and better manage their operations.

Panel Tags

Rugged, light weight and available in a variety of fade-resistant colors. Destron Fearing™ panel tags are designed for superior retention, all weather performance and easy application when used with the ProGriplI™ Universal Tag Applicator.

Custom Tags

Custom marking is available including logos, lines of text and reverse side marking. Customized brands and images can be produced with a provided image.

Premium Performance RFID

Our e.Tags® are designed to provide optimal read range and superior cold weather application. Each contains a passive, ISO-compliant (134.2 kHz) RFID transponder encoded with a 15-digit identification number that can be read in millisecond by any Destron Fearing™ or ISO-compliant reader.

Dark & Durable Marking

Dark & Durable™ tag marking begins with the Destron Fearing laser mark that is etched into the tag surface using a computer guided laser beam resulting in a dark gray mark. The laser mark is then overlaid with black ink resulting in bold, black numbers.



INFECTA+GUARD® Infecta+Guard™ included on all stock tags.

Questions

Call 1-800-328-0118 or email customerservice@destronfearing.com

www.destronfearing.com



Destron Fearing™
by Allflex



Reader and Accessories



Leg Bands

SKU: AC7003**

** = Leg Band Colors:

01 = Orange, 02 = Yellow, 05 = Red,
06 = Blue, 07 = Green, 14 = Neon Orange,
15 = Neon Yellow, 16 = Neon Green, 17 = Neon Pink



Super Mark Pen™

SKU: AC7001



E-Z Knife™

SKU: AC7004



ProGriplI™ Applicator

SKU: AC7066

ProGriplI™ replacement pin: SKU: AC7008

Swine Identification Tags



- Hog Max is the industry leader for breeding age swine
- Center post stud design maximizes the rate of retention
- Longer tapered tip for superior piercing ability
- Rectangular panel enhances readability and printing options for complex barcodes and logos
- Can accommodate multiple lines of custom printing and designs including barcodes and logos
- Hog Max² combines all the attributes of the Hog Max along with the addition of a square female



- Litter Max²™ is the industry leader for use in genetic management programs
- Designed specifically for piglets from birth to approximately 40 lbs
- Non-metal tip
- Square male and female design provide maximum retention from birth to harvest
- Square panel enhances readability and printing options for complex barcodes and logos
- Litter Max utilizes the same square male but will only have a round female



- Standard Round stud is most commonly used with feeder age pigs
- Universal size is designed for use in swine of any age
- Metal tip
- Round shape and fast taper tip provide superior piercing ability

Available Colors and Codes



Black = 08 - Available in Standard Round only.

Official USDA Swine Premises Tags



SKU: SWPTSET**06D (Numbered Premises Tags)
 SKU: SWPTSET**06L (Blank Premises Tags)
 ** = Color Code



Purposes

- Meets USDA and Pork Industry Standards
- Improves Traceback Accuracy, Speed & Efficiency
- Supports Comprehensive Disease Surveillance Programs

Implementation

- Tags Must Have Premises ID, Shield, and State
- PIN of Last Farm Required
- Tags Must be Applied Prior to Harvest Channel Entry
- Cull Sows & Boars Required to have PIN Tag

Electronic ID



ESF80 - FDX Technology

1.2" Diameter
 *Designed for ESF Stations
 Product Code: ESF80BTN02L

SKU: ESF80BTN02L = ESF80 RFID female only
 SKU: ESF80SET22 = ESF80 RFID and Round Hog male - Yellow
 SKU: HMEF80SET22 = ESF80 RFID and Hog Max male - Yellow



e.Tag™ - FDX Technology

Size: 1.2" Diameter
 SKU: ANESET
 Tag weight: 9.18 grams



SW50 - FDX Technology

1.0" Diameter
 *Designed for pigs (Wean-to-Finish age)
 Product Code: SW50SET

SKU: SW50BTN02L = RFID female only - Yellow
 SKU: SW50SET22 = SW50 RFID and Round Hog male - Yellow
 SKU: HMSW50SET22 = SW50 RFID and Hog Max male - Yellow



HD.tag™ - HDX Technology

Size: 1.2" Diameter
 SKU: ANHDSET
 Tag weight: 8.0 grams

Available Colors and Codes



**Some colors are not available in all tag sizes. Please contact customer service for more information. Black = 08 - Available in Standard Round only.*



Extra Large Female
Size: 3" high x 4 5/8" wide
SKU: XLSET

Extra Large Female

- Used primarily for mature cattle
- Laser-ink management number standard
- Largest panel for management information
- Highly visible from both front and back
- Especially useful in cold climates for animals with longer hair
- Packaged with Global Small Male



Extended Female
Size: 2 1/2" high x 4" wide
SKU: EXTSET

Extended Female

- Our most popular size for both mature cattle and calves
- Laser-ink management number standard
- Excellent for beef and dairy cattle
- Packaged with Global Small Male



Large Female
Size: 2 1/4" high x 2 3/4" wide
SKU: LGSET

Large Female
Size: 2 1/4" high x 2 3/4" wide
SKU: LGSET

Large Female

- Used primarily for calves
- Laser-ink management number standard
- For use in beef and dairy cattle
- Packaged with Global Small Male

Large Male

- Best used for beef and dairy cattle
- Provides visibility from behind an animal
- Can be used in combination with any Allflex Global Female tag
- Packaged without female tags (quantities of 25)



Sheep & Goat
Size: 2" high x 7/8" wide
SKU: SGSET

Sheep & Goat

- Provides good visibility without weighing ear down
- Global Sheep Female and Global Sheep Male packaged standard in sets of 25 – blank or numbered sequentially
- In numbered sets, both male and female are laser marked
- Available in yellow, red, green, pink, blue, orange and white (not available in purple or magenta)



Medium Female
Size: 1 3/4" high x 1 7/8" wide
SKU: MDSET

Medium Female

- Used for calves, hogs, goats and sheep
- Laser-ink available on management numbers larger than 1/2"
- Packaged standard with Global Small Male
- Not available in Green or Pink



Standard Round
Size: 1 1/8" Diameter
SKU: RHGSEST

Standard Round

- Self-piercing tip
- Engineered for superior retention
- Numbered Global Small Male packaged standard with blank Global Small Female
- Also available with extended shaft for thicker ears
- Available blank in packages of 25 without female companion



Extra Large Choice Set
Size: 3" high x 4 5/8" wide
SKU: RHGSEST



e.Tag™ - FDX Technology
Size: 1.2" Diameter
SKU: ANESET
Tag weight: 9.18 grams



HD.tag™ - HDX Technology
Size: 1.2" Diameter
SKU: ANHDSET
Tag weight: 8.0 grams

NEW!

RS420 Stick Reader

RS420 Stick Reader

60cm - SKU: RS420-60
45cm - SKU: RS420-45



Allflex RS420 Stick Reader

- Portable reader with cord-free capabilities
- ISO Compatible with both FDX and HDX technologies
- Internal battery, LCD read out and tag counter option
- Pro Kit available for both sizes: RS420-60-KIT RS420-45-KIT

RS420 Enhancements

- High Contrast LCD
- Cable free Operation
- Internal Bluetooth
- Rechargeable 7.4 VDC Li-Ion Battery
- 100,000 ID Tag Storage (10,000 per session)
- Comes Standard with EID Tag Manager Software

RS420 Stick Reader "Pro Kit"

- Rugged hard-sided plastic case
- PW420 Replacement Battery Pack 7.4VDC
- EID Tag Manager Software
- Pro Kit available for both sizes: RS420-60-KIT RS420-45-KIT



LPR EID Reader

- Portable
- Cable Free
- Internal Bluetooth
- Rechargeable 7.2 VDC NiMH battery pack

Indicators		
Disabled	Flashing	Fixed
Reader OFF	Reader is reading	Reader is ON
	Tag read	
Battery OK	Battery level getting low	Battery depleted Charge necessary
Bluetooth disabled	Blinking once every second: not connected (slave mode)	Bluetooth connected
	Blinking 5 times every 5 seconds: not connected (master mode) tried to establish a connection	



SKU: LPR-COVER

- Shock Resistant Cover
- Safety Strap
- Lightweight
- ISO 11784 & 11785 Compliant
- SKU: LPR

AWR300 Stick Reader

The AWR300 is the next generation Key Features Include:

EID Stick Reader and features a 8GB memory with a large back-lit display.

The AWR boasts an ingress protection, rating of IP67. It is lightweight, well balanced and comfortable in the hand.

- Long read range (30cm or 12")
- Outstanding battery life, even at top power consumption, in continuous read mode, the LI-Ion Battery will last for around 12 hours
- 8GB Memory for up to 1 million records. Record tag numbers with time stamp data and additional information
- The database function can display several items of data at once and add new information for an individual animal from defined lists including breeds or medicines
- Activities announced by multiple LED lights, plus a choice of sounds and vibration, to ensure you never miss an action
- Large back lit color display, to clearly read ID's at scanning, even in dim light
- Light weight, well balanced with a robust construction and weatherproof to IP67 standard
- Built in real time clock, displays Date and Time
- Connect to external devices using either WLAN, USB or Bluetooth connection

AWR300 STICK READER
SKU: AWR300



RUGGED HARD-SIDED PLASTIC CASE

SKU: AWR300-KIT
SKU: ATB300 (case only)



Reading Systems-Chuteside Applications



Allflex SKU: FFW6000

Fixed Feedlot Wand (FFW)

- Designed to scan animals during processing at chute
- Viewable lights indicate when the device is turned on and in operation
- Flexible, retractable connection with removable wand
- Comes complete with external power supply
- No internal tag storage, sends RFID numbers direct to scale indicator, computer or handheld device with suitable software.
- Compatible with most major scales and software
- Reads both FDX-B and HDX ISO 11784/11785 compliant EID products
- Built to withstand the harshest of conditions
- Also available with tag storage and “sync” capability in model Aleis-FFW8050



Allflex SKU: FFWNB9060

Neck Bars

- Designed to read cattle in chute
- Consists of two antennas mounted on the front of the chute
- Designed to read in the “HELD” position
- Includes a back-up wand for improper positioned animals
- Storage of up to 100,000 RFID numbers
- Comes complete with external power supply
- Sends RFID numbers direct to scale indicator, computer or PDA
- Compatible with most major scales and software
- Reads both FDX-B and HDX ISO 11784/11785 compliant EID products
- Designed specifically to handle chute reading conditions

“FAST, ACCURATE AND EFFICIENT”

Antenna System



Allflex SKU: 8152BT

8152BT - Single Antenna System

- Designed for use in load-in/out alleyways or on a scale system
- The panel has an Auto-Tuning function
- Includes Removable Reader Box w/Bluetooth & 1200x600x21 or Antenna 900x450x21mm
- Comes with (2) built in 12VDC batteries housed just below the control box for remote usage
- Visual Screen and Keypad allow the user to view tag data and change reader settings as needed
- This unit will store up to 100,000 individual Electronic ID numbers and can be configured to compare EID numbers and send an alert when a specific number is scanned
- Reads both FDX-B and HDX ISO 11784/11785 compliant EID products
- Reader includes Battery Charger, Data Lead, USB Adapter and User’s Manual



Allflex SKU: 9162BT

9162BT - Single Antenna System

- Designed for use in load-in/out alleyways or on a scale system
- The panel has an Auto-tuning function
- Includes Removable Reader Box w/Bluetooth & 1200x600x21 or Antenna 900x450x21mm
- Comes with (2) built in 12VDC batteries housed just below the control box for remote usage
- Visual screen and QWERTY keypad allow the user to view tag data, input data in up to four configurable fields and change reader settings as needed
- This unit will store up to 100,000 individual Electronic ID numbers and can be configured to Compare EID numbers and send an alert when a specific number is scanned.
- Reads both FDX-B and HDX ISO 11784/11785 compliant EID products
- Reader includes Battery Charger, Data lead, USB Adapter and User’s Manual



Allflex SKU: 610 Multi A&B

Dual Panel Antenna Systems

- Designed for “High Volume” load-in and load-out of animals
- Two antennas, 1200x600x21mm or 900x450x21mm
- External power supply required, not included
- Sends RFID numbers direct to scale indicator, computer, handheld device or sent to remote data storage box
- Compatible with most major scales and software
- Reads both FDX-B and HDX ISO 11784/11785 compliant products

All panel antennas require a site survey from our sales staff or technical department and are installed by our technical team.

The Allflex EID Tag is a crucial part of an electronic identification system. As such, the tag is simply the first of four elements needed for complete data collection and management. Data collection systems are varied and constantly evolving. They typically include:

- 1  **EID Device**
(Allflex High Performance Tamperproof EID Tag)
- 2  **Stick Reader**
(Allflex AWR300 Stick Reader)
- 3  **Software**
(Compatible with most livestock management software providers)
- 4  **Computer**
(Or livestock scale indicator)

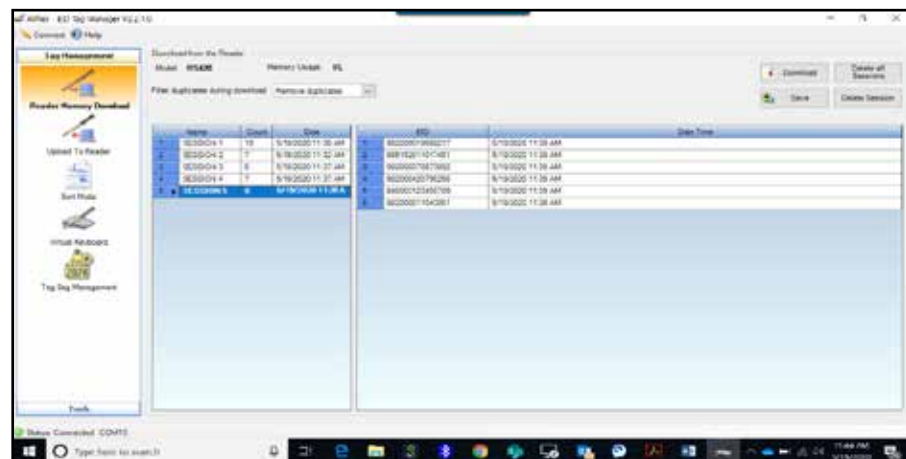

EID Tag Manager software can be downloaded for FREE from our website at www.allflex.global/na



Allflex EID Tag Manager Software allows the Allflex Reader user to manage basic reader functions and download EID tags

- To manage an Allflex Reader connected to a PC thru serial ports, USB to Serial or Bluetooth connection
- To download tag data stored in an Allflex Reader and save the file in Excel or Word documents
- To use EID tag manager as a wedge program to scan EID numbers directly into Excel, Word or other application
- To reduce data entry when associating EID numbers with management numbers by using web link to download EID tag numbers

Download the Free Allflex eList App Today



The Allflex eList app provides a simple way to create digital records using Allflex Livestock Intelligence's readers. Create custom lists for visual ID, electronic ID, Tissue Sample Unit and Monitoring ID with user defined fields. These lists can be exported as a .CSV file and can include dates, time stamps and GPS coordinates

1. Initial walkthrough will help you get started and settings can be changed at any time to create a new list with different content.



2. In General Settings, items to collect and other options can be changed.

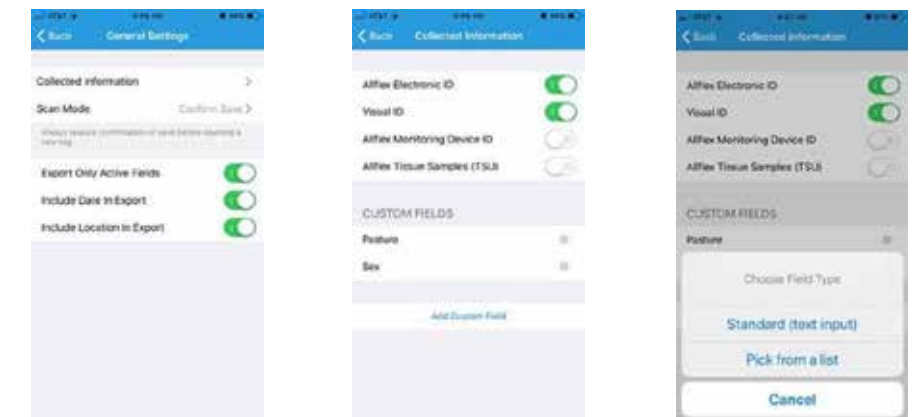

3. The app can save multiple lists, any one of which can be selected for additions, editing or deletion.

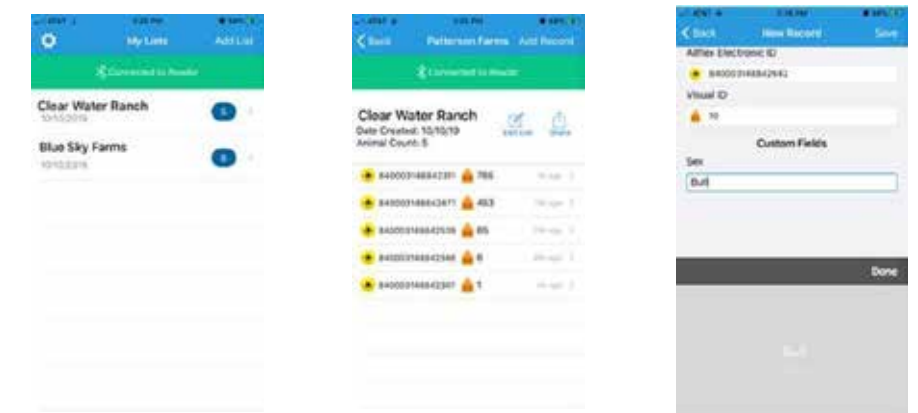

Allflex eList can create custom lists for Electronic ID (including Destron Fearing, ISO Country Coded and 15 digit tags), Visual ID, Tissue Sample Unit Information and Monitoring devices

Allflex eList records data from Allflex AWR300, LPR, RS420 and GPR+ readers

Allflex – Tissue Sampling Technology

Collecting tissue samples has never been more efficient and cost effective. Scientific advancements in the mapping of livestock genomes along with continued development of affordable analytics has changed the sampling industry – making it easier and quicker for producers to use DNA for:

- Parentage verification
- Genetic selection
- BVD diagnostics
- Fast, high performance sample collection ... Samples can be collected in seconds with minimal animal restraint. A single-squeeze motion collects a sample with minimum distress to the animal.
- Clean, uncontaminated sampling ... The genetic material is sealed in a specially designed preservative.
- Visual, DNA-sample identification ... Instant confirmation of on-farm sampling success. No more guessing whether enough genetic material has been gathered.
- Minimize retesting ... Tissue samples contain a large quantity of high quality DNA for genetic analysis yielding excellent lab results.

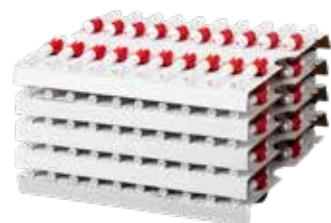

Tissue Sampling Unit-Box of 100
SKU: AF-TSU-100



Tissue Sampling Unit-Box of 10
SKU: AF-TSU-10



Tissue Sampling Applicator
SKU: APP-TSU



TSU Tray
SKU: TSU-TRAY-B



TSU Tray + Lid
SKU: TSU-TRAY+LID

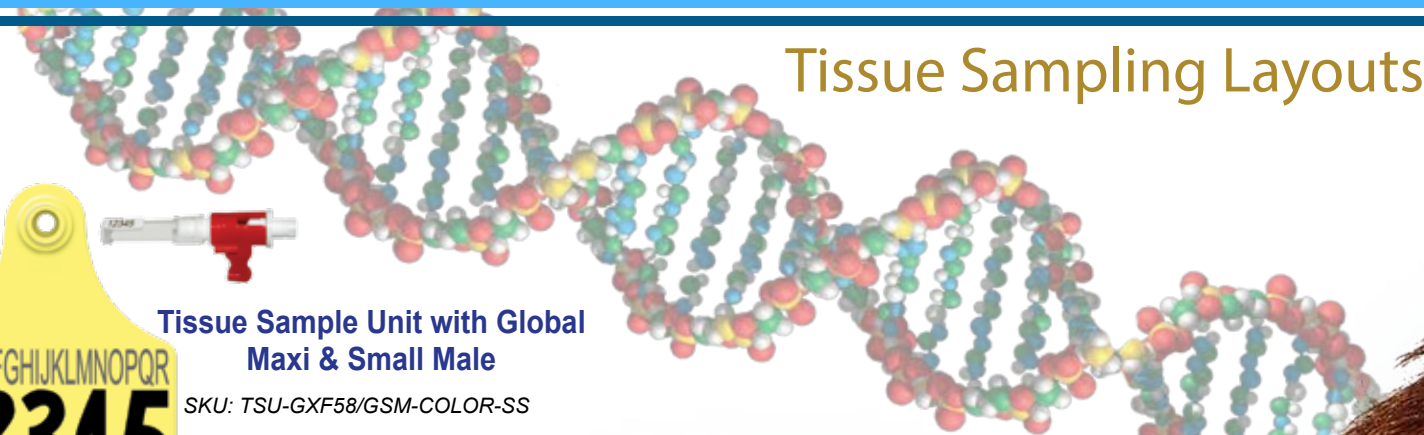

Tissue Sampling Layouts

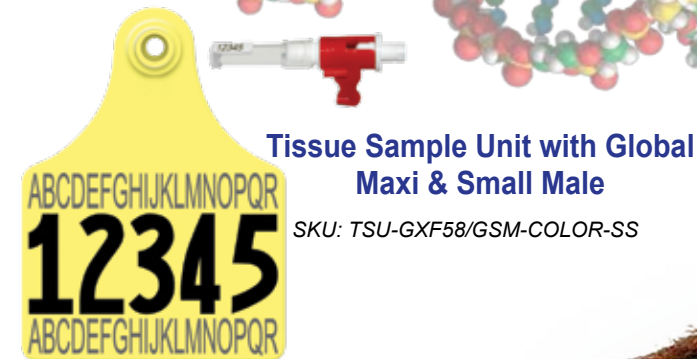

Tissue Sample Unit with Global Maxi & Small Male
SKU: TSU-GXF58/GSM-COLOR-SS

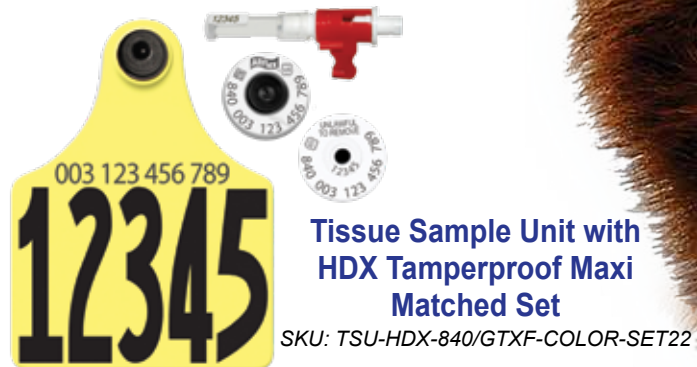

Tissue Sample Unit with HDX Tamperproof Maxi Matched Set
SKU: TSU-HDX-840/GTXF-COLOR-SET22



Tissue Sampling Unit with HDX Tamperproof Maxi & Large Male Matched Set
SKU: TSU-HDX840/GTXF1-GLM1-COLOR

Tissue Sample Unit with HDX ATag™ Cow Matched Set
SKU: TSU-HDX840/ATAGX-COLOR-SET17



More options available
Visit www.allflex.global/na



MAKING ID EASY

Allflex Matched Set Combinations

Producers continue to use our Visual Tag, Electronic Tag and Tissue Sampling Units in combination. We've developed some efficiencies in the numbering of these sets, in order to eliminate the need to "match" these devices at a later date.

Just apply the entire ID set to your animal and the Management number, EID number and TSU are permanently connected for ease of record keeping. Download the file from our website to save or share the information with your herd management program, breed association or genomics lab. (Management numbers can be in sequence or totally custom to better match your herd needs.)

Use for calves, replacement females, bull sale tags or whatever your need!

Simple, effective and cutting edge!

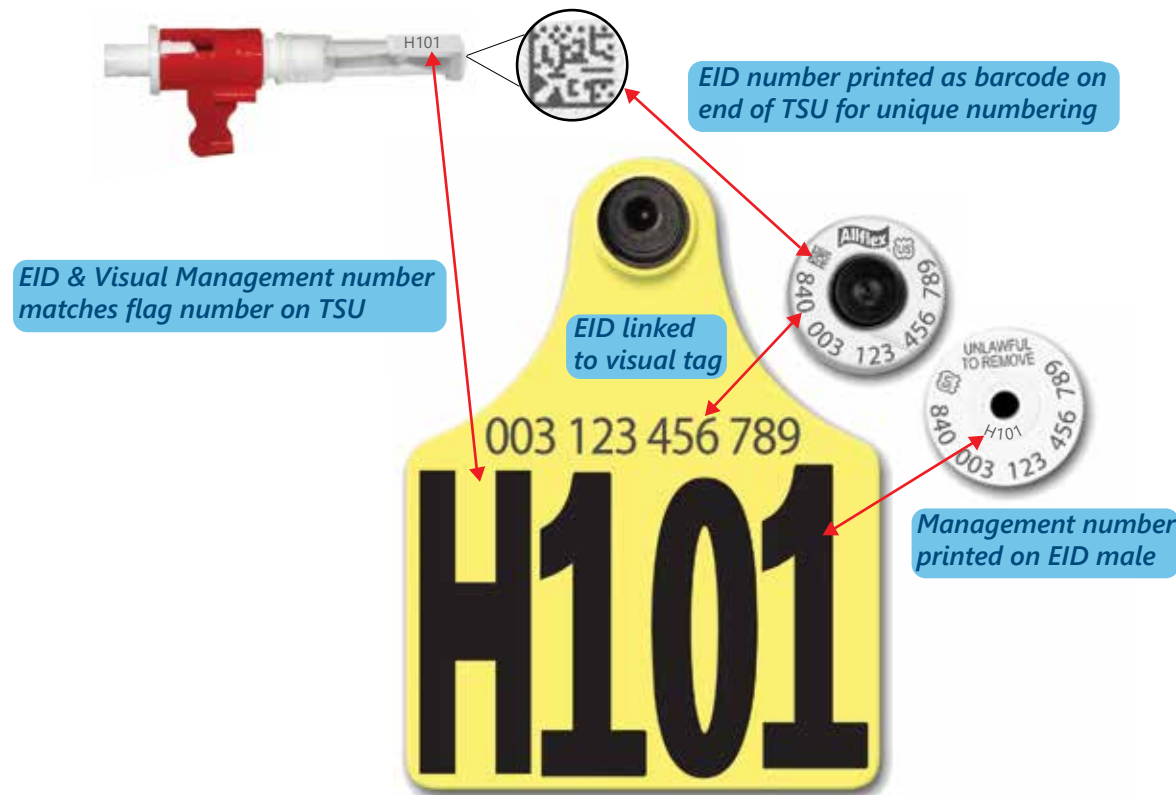

For Tag Lookup visit: <https://flexlink.allflexusa.com/Search>

Allflex 2-in-1 Marking Pens

- One pen with two marking tips (fine and broad)
- Easy-to-hold and easy-to-use pump action
- Fade resistant black or white ink
- Specially formulated for use on Allflex Ear Tags



Allflex 2-in-1 Marking Pens
SKU: PEN



SKU: PEN-WHITE

TIPS FOR MARKING

- 1** Wipe tag surface clean with isopropyl (rubbing) alcohol.
- 2** Mark tag indoors in a well ventilated area at room temperature. Keep the internal valve partially open by applying slight, constant pressure on the tip.
- 3** Write numbers and letters slowly for heavy inking and durable marking. Insufficient ink will cause the markings to fade prematurely.
- 4** Mark at least two times, allowing for proper drying between markings for best results.
- 5** If possible, dry tags in a warm, sunny area as this enhances ink penetration. Allow mark to dry thoroughly before tagging animal.

Patented Laser-Ink Marking

- Laser-ink marking allows for greater visibility of management numbers in livestock applications
- The patented marking process is exclusive to Allflex
- The durable laser mark is guaranteed to last the life of the animal



MONITORING EACH INDIVIDUAL

We do everything for the cows to keep them healthy and happy. We treat each cow as an individual and Allflex Monitoring helps us identify individual cows that need attention.

— Larry Pietrowski, Costa View Farms

By tracking rumination, heat cycles and health data, Allflex Monitoring helps dairy producers monitor each cow individually, from anywhere in the world.

The future of cattle management is here.

Allflex
Livestock Intelligence™

WWW.ALLFLEX.GLOBAL/NA | 800.989.8247

Repeater Syringes



50MR2

(Adjustable dosage from 1ml to 5ml)
SKU: 50MR2



50MR2

- Accurately delivers selected dose
- Easy grip for high volume use
- Barrel and needle attachment are fully autoclavable
- Streamlined design with fewer replacement parts
- Amber-colored barrel reduces UV sunlight exposure
- Color Knob Pack available to differentiate between medications



LONG RANGE BARREL

The LR Barrel is designed for use with extended release deworming products that require a specialized plastic barrel.

SKU: LR-BARREL



SGNOZZLE/BARREL

Sheep & Goat Drench Barrel

SKU: 50MR SG NOZZLE/BARREL

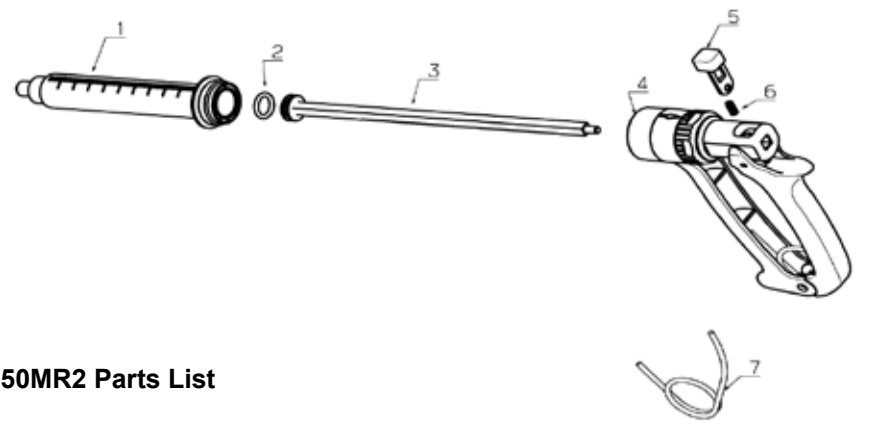

50MR2 Parts List

SKU	Item	Description
50MR2-PO	2	Piston O-Ring 50 ML
50MR2-B	1	Plastic Barrel 50 ML LL
50MR2-B/PO		Barrel & Piston O-Ring
50MR2-RH		Replacement Handle
50MR2-PR/R	3	Piston+Piston Rod 50 ML
50MR2-RH	4	Handle 50 ML CPL
MR2-LS	5	Locking Sleeve CPL
MR2-LSSP	6	Spring for Locking Sleeve
MR2-HS	7	Handle Spring
MR2-KNOB-K	8	Knob Black
MR2-KNOB-B	8	Knob Blue
MR2-KNOB-R	8	Knob Red
MR2-KNOB-Y	8	Knob Yellow
MR2-KNOB-PACK	8	Knob Pack

Repeater Syringes



25MR2

(Adjustable dosage from .5ml to 2.5ml)
SKU: 25MR2



25MR2

- Accurately delivers selected dose
- Easy grip for high volume use
- Barrel and needle attachment are fully autoclavable
- Streamlined design with fewer replacement parts
- Amber-colored barrel reduces UV sunlight exposure
- Color Knob Pack available to differentiate between medications



LONG RANGE BARREL

The LR Barrel is designed for use with extended release deworming products that require a specialized plastic barrel.

SKU: LR-BARREL

ACCESSORIES

Color Code Injection Accuracy System

Interchangeable colored knobs let you dedicate a particular syringe to a selected vaccine or therapeutic compound to ensure proper administration and avoid mistakes.



(MUST BE ORDERED SEPARATELY)

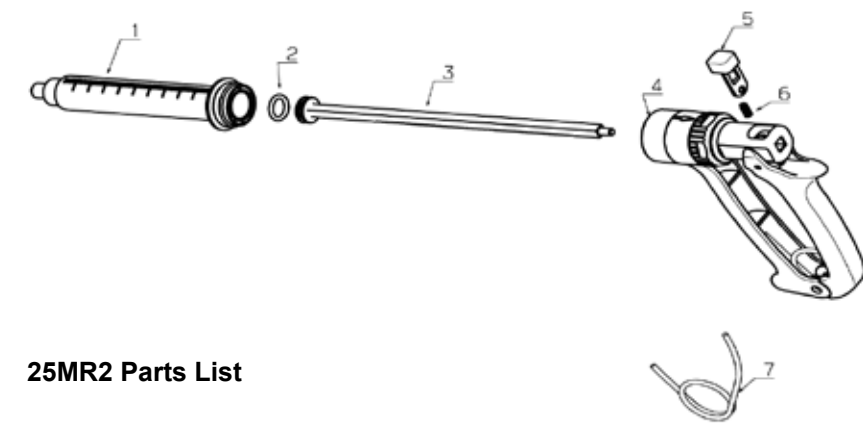

25MR2 Parts List

SKU	Item	Description
25MR2-PO	2	Piston O-Ring 25 ML
25MR2-B	1	Plastic Barrel 25 ML LL
25MR2-B/PO		Barrel & Piston O-Ring
25MR2-RH		Replacement Handle
25MR2-PR/R	3	Piston+Piston rod 25 ML
25MR2-RH	4	Handle 25 ML CPL
MR2-LS	5	Locking Sleeve CPL
MR2-LSSP	6	Spring for Locking Sleeve
MR2-HS	7	Handle Spring
MR2-KNOB-K	8	Knob Black
MR2-KNOB-B	8	Knob Blue
MR2-KNOB-R	8	Knob Red
MR2-KNOB-Y	8	Knob Yellow
MR2-KNOB-PACK	8	Knob Pack

EM Syringes

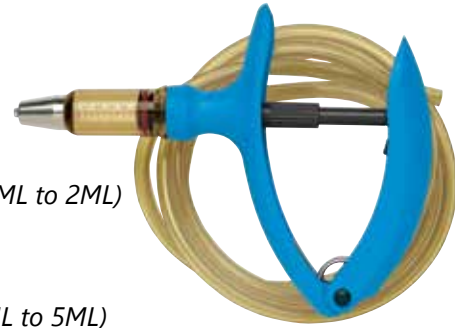

2EM
(Adjustable dosage from .25ML to 2ML)
SKU: 2EM

5EM
(Adjustable dosage from .5ML to 5ML)
SKU: 5EM



2EM & 5EM Tube Fed Syringes

- Accurately delivers selected dose
- Easy V-grip for high volume use
- Metal Luer Lock Tip
- Removable barrel for cleaning
- Durable plastic design
- Amber-colored barrel and tubing reduce UV sunlight exposure

LD.3EM-BT
(Adjustable dosage from .1ML to .3ML)
SKU: LD.3EM-BT

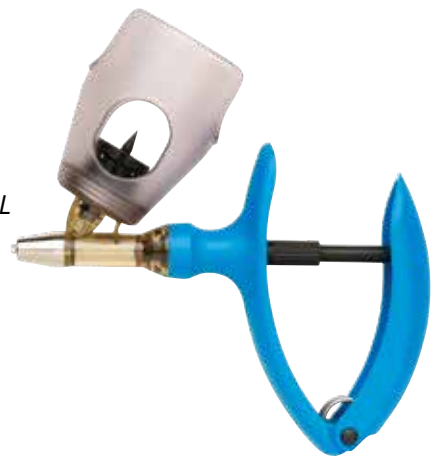

2EM-BT
(Adjustable dosage from .25ML to 2ML)
SKU: 2EM-BT

5EM-BT
(Adjustable dosage from .5ML to 5ML)
SKU: 5EM-BT

LD.3EM, 2EM & 5EM Bottle Fed Syringes

- Automatic self-filling with bottle attachment
- Heavy-Duty Bottle Cage for bottle protection (50ML & 100ML bottles only)
- Accurately delivers selected dose
- Easy V-grip for high volume use
- Metal Luer Lock Tip
- Removable barrel for cleaning
- Durable plastic design
- Amber-colored barrel reduces UV sunlight exposure
- Plastic Atomizer Nozzle - SKU: 8300042687

2EM-BT-UBA
(Adjustable dosage from .25ML to 2ML)
SKU: 2EM-BT-UBA-GRAY



5EM-BT-UBA
(Adjustable dosage from .5ML to 5ML)
SKU: 5EM-BT-UBA-GRAY

2EM & 5EM Bottle Fed Syringe with Universal Bottle Adapter

- Automatic self-filling with Universal Bottle Adapters
- Five color coded "Universal Bottle Adapters" included
- Universal Bottle Adapters enable multi-size bottles to fit on the syringe
- Metal Luer Lock Tip
- Removable barrel for cleaning
- Durable plastic design
- Amber-colored barrel reduce UV sunlight exposure

Universal Bottle Adapters



Measurements:
Blue: 250ml / 30mm
Black: Specialized 250/500ml / 34mm
Green: 250ml / 500ml / 33mm
White: 50ml / 100ml / 20mm
Red: 250ml / 30.5mm

SKU	Description	SKU	Description
2EM	2ML AUTOMATIC REUSABLE SYRINGE	5EM	5ML AUTOMATIC REUSABLE SYRINGE
2EM-3	2ML AUTOMATIC REUSABLE SYRINGE w/3 DRAW OFFS	5EM-3	5ML AUTOMATIC REUSABLE SYRINGE w/3 DRAW OFFS
2EM-A	2ML AUTOMATIC REUSABLE SYRINGE w/20MM DRAW	5EM-A	5ML AUTOMATIC REUSABLE SYRINGE w/20MM DRAW
2EM-B	2ML AUTOMATIC REUSABLE SYRINGE w/30MM DRAW	5EM-B	5ML AUTOMATIC REUSABLE SYRINGE w/30MM DRAW
2EM-C	2ML AUTOMATIC REUSABLE SYRINGE w/33MM DRAW	5EM-C	5ML AUTOMATIC REUSABLE SYRINGE w/33MM DRAW
2EM-S	2ML AUTOMATIC REUSABLE SYRINGE w/PLASTIC SPIKE	5EM-S	5ML AUTOMATIC REUSABLE SYRINGE w/PLASTIC SPIKE
EM.3ORING	PISTON O-RING 0.3 ML	EM1ORING	PISTON O-RING 1 ML
EM.5ORING	PISTON O-RING 0.5 M	EM2ORING	PISTON O-RING 2 ML
		EM5ORING	PISTON O-RING 5 ML

UM Syringes



1UM-T
(Adjustable dosage from .1ML to 1ML)
SKU: 1UM-T

2UM-T
(Adjustable dosage from .1ML to 2ML)
SKU: 2UM-T

2UM Tube Fed Syringe

- Automatic self-filling tube feed
- Adaptable to bottle feed
- Accurately delivers selected dose
- Ergonomic grip for comfort
- Steel Plunger (no O-ring) with precision glass barrel
- Adjustable pin-lock handle design

2UM Bottle Fed Syringes

- Heavy-Duty Bottle Cage for bottle protection (50ML or 100ML bottles only)
- Adaptable to tube feed
- Accurately delivers selected dose
- Easy grip for high volume use
- Steel Plunger (no O-ring) with precision glass barrel
- Adjustable pin-lock handle design

2UM
(Adjustable dosage from .1ML to 2ML)
SKU: 2UM



5UM-BT/T
(Adjustable dosage from .5ML to 5ML)
SKU: 5UM-BT/T



5UM-BT/T Automatic Syringe

- 5ML automatic self-filling syringe
- Adaptable as a tube feed syringe or bottle top syringe
- Steel Plunger (no O-ring) with precision glass barrel
- Adjustable pin-lock handle design for easy conversion
- Heavy-Duty Bottle Cage for bottle protection (50ML & 100ML bottles only)

SKU	Item	Description		
1UM-B	2UM-B	5UM-B	1	Glass Barrel 1ML/2ML/5ML
1UM-MSK	2UM-MSK	5UM-MSK	2	Major Service Kit
1UM-SK	2UM-SK	5UM-SK	3	Minor Service Kit
		5UM-BT		
		5UM/T-3		
XP14	XP14	XP14	1	Nozzle Luer-Lock
XP01	XP01	XP01	2	Washer
XP02	XP02	XP02	3	Compressing Spring
XP03	XP03	XP03	4	Metal Ball
1UM04	2UM04	5UM04	5	Barrel Sleeve
XP04	XP04	XP04	6	Sleeve
XP05	XP05	XP05	7	Handle Black
XP06	XP06	XP06	8	Piston Rod w. Handle
1UM08	2UM08	5UM08	9	Piston
XP10	XP10	XP10	10	Adjusting Sleeve
1UM10	2UM10	5UM10	11	Washer
XP08	XP08	XP08	12	Compressing Spring
XP09	XP09	XP09	13	Washer
XP11	XP11	XP11	14	Compressing Ring
XP12	XP12	XP12	15	Knurled Screw
1UM-B	2UM-B	5UM-B	16	Glass Barrel 1ML
XP13	XP13	XP13	17	Washer
XP-BATT	XP-BATT	XP-BATT	18	Bottle Attachment w/o Basket
XP-CAGE	XP-CAGE	XP-CAGE	19	Basket
XP17	XP17	XP17	20	Valve Screw
XP16	XP16	XP16	21	Pin
1UM11	2UM11	5UM11	22	Washer

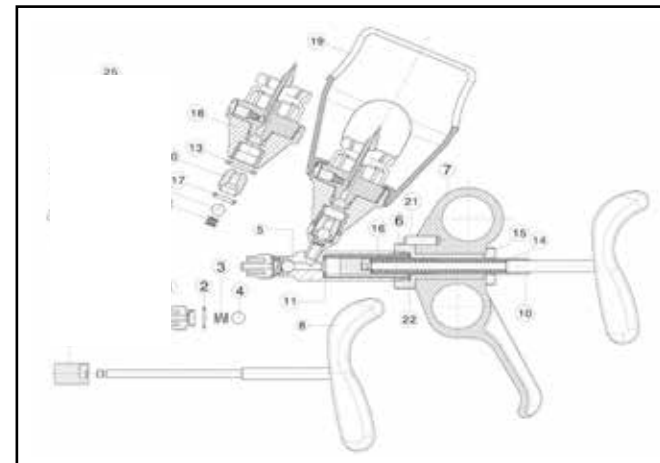

Draw-Off Syringes



5VM Draw-Off Injection Syringe

- Automatic self-filling tube feed
- Accurately delivers selected dose
- Easy grip for high volume use
- Piston and O-ring Plunger
- Amber-colored barrel and tubing reduce UV sunlight exposure

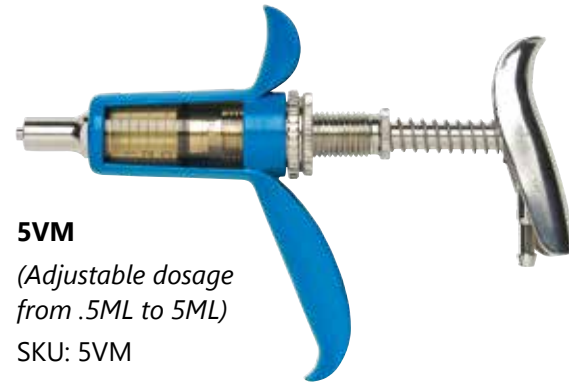

5VM
(Adjustable dosage from .5ML to 5ML)
SKU: 5VM

SKU	Item	Description
5VM		5ML Automatic Syringe Tube Feed
5VM-A		5ML Automatic Syringe Tube Feed/20MM Draw Off
5VM-B		5ML Automatic Syringe Tube Feed/30MM Draw Off
5VM-C		5ML Automatic Syringe Tube Feed/33MM Draw Off
5VM-3		5ML Automatic Syringe Tube Feed/20,30,33MM Draw Off
XP20	1	Barrel Housing
5VM02	2	Mounting Hub
XP21	3	Plastic Barrel 5 CC
5VM03	4	Piston Rod
XP21-SPRING	5	Compression Spring
XP22	6	Dose Rod
XP23	7	Locking Nut
XP24	8	Barrel Lock Nut
5VM08	9	Piston
XP25	10	O-ring
XP26	11	Valve with Washer
XP02	12	Valve Spring
XP08	13	Valve Spring
5VM13	14	Front Luer Lock
XP27	22	Washer
AT18	24	PVC Amber Tube
5VM-SK	10(2ea),11(2ea),12,13	Minor Service Kit
5VM-MSK	3,10(2ea),11(2ea),12,13	Major Service Kit

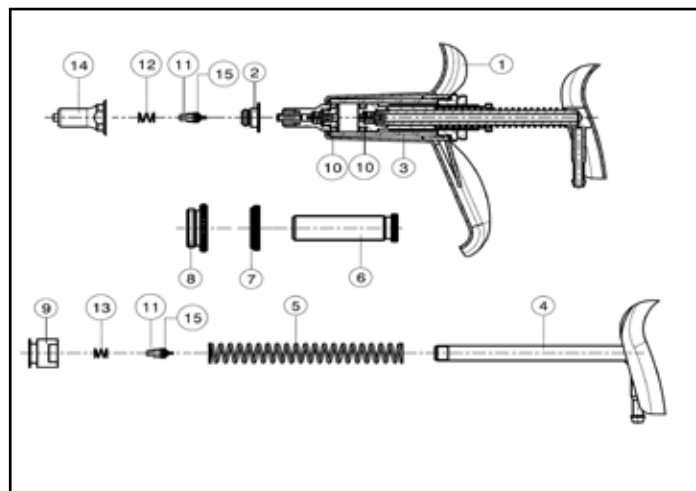

10VM
(Adjustable dosage from .5ML to 10ML)
SKU: 10VM-S

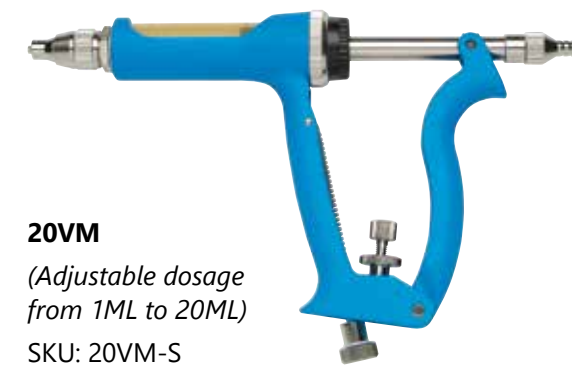

20VM
(Adjustable dosage from 1ML to 20ML)
SKU: 20VM-S

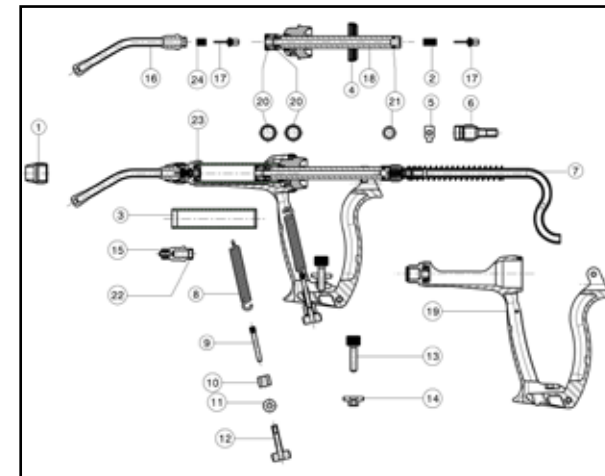

Drench Nozzles

- 5 1/2" Drench Nozzle for 10VM/20VM
SKU: **D-NOZ**
- 3" Drench Nozzle for 10VM/20VM
SKU: **S-NOZ**

10VM & 20VM Draw-Off Injection Syringes

- Automatic self-filling tube feed
- Designed to be used as an injector or drencher
- Accurately delivers selected dose
- Easy V-grip for high volume use
- Easy to adjust handle tension for improved performance
- Durable metal and plastic design
- Double O-ring Piston
- Easy-to-clean external valves and removable piston shaft
- Amber-colored barrel and tubing reduce UV sunlight exposure

SKU	Item	Description
10VM-S	20VM-S	10ML & 20ML Automatic Syringe
10VM-S-A	20VM-S-A	10ML & 20ML Automatic Syringe/20MM Draw Off
10VM-S-B	20VM-S-B	10ML & 20ML Automatic Syringe/30MM Draw Off
10VM-S-C	20VM-S-C	10ML & 20ML Automatic Syringe/33MM Draw Off
10VM-S-3	20VM-S-3	10ML & 20ML Automatic Syringe/20, 30, 33MM Draw Off
10VM-SD	20VM-SD	10ML & 20ML Automatic Syringe/Drencher
10VM-ORING	20VM-ORING	20 18 Piston O-ring (20ML)
10VM-HAN	20VM-HAN	19 Complete Handle Assembly
10VM-BAR	20VM-BAR	3 Amber Plastic Barrel
LLTIP	LLTIP	15 Luer Lock Nozzle
XP36	XP36	1 Nozzle Nut
XP37	XP37	5 & 17 Valve with O-ring
XP38	XP38	2 & 24 Valve Spring
10VM-ROD	20VM-ROD	18 7 Piston Rod 20ML
XP39	XP39	4 Retaining Nut
XP40	XP40	6 Tubing Attachment
AT-10VM	AT-20VM	7 PVC Tube length 1,7 m
XP41	XP41	8 Draw Spring
XP42	XP42	9 Spring Rod
XP43	XP43	14 Dosage Lock Nut
XP44	XP44	13 Dosage Screw
XP45	XP45	10 Tension Bushing
XP46	XP46	11 Tension Washer
XP47	XP47	12 Tension Screw
XP48	XP48	17 Lever Wear Pads (One-piece)
XP49	XP49	21 O-ring (Rear Valve Housing)
XP50	XP50	22 O-ring LL+Drench Nozzle
XP13	XP13	20 O-ring (Luer Lock Nozzle and Drench Nozzle)
10VM01	20VM01	23 O-ring (Barrel Mounting Hub)
10VM-SK	20VM-SK	5(2ea),6(2ea),17, 18(2ea),19,20(2ea),21 Minor Service Kit Includes: Washer, Valve Spring, Ball (2ea.), Washer, Valve, Spring Washer, O-ring, Washer (Red)
10VM-MSK	20VM-MSK	2,5(2ea),6(2ea),17, 18(2ea),19,20(2ea),21 Major Service Kit Includes: Washer, Valve Spring, Ball (2 ea.), Washer, Valve Spring, Washer, Washer, Glass Barrel (2ml), O-ring, Washer (Red)
BACK 25	BACK 25	2.5 Liter Back Pack
BACK 5L	BACK 5L	5 Liter Back Pack
D-NOZ	D-NOZ	5 1/2" Drench Nozzle
S-NOZ	S-NOZ	3" Drench Nozzle

Allflex HSW EM Fixed Dose Syringes

- **Automatic self-filling syringe for injection**
- **Fixed Dose .5ML (Gray), 1ML (Red) and 2ML (Black)**

Syringes are fixed at the specific dosage for each model, for accuracy in dispensing medications and vaccines. The dosage cannot be changed or adjusted with these models. These syringes have an accuracy guarantee of $\pm 2\%$ to dispense the set dosage.

.5ML EM Fixed Dose UBA (Universal Bottle Adapter)

White (20MM) and Blue (30MM) Bottle Collar
SKU: .5EM-BT-UBA-FD (Color = Gray)

1ML EM Fixed Dose UBA (Universal Bottle Adapter)

White (20MM) and Blue (30MM) Bottle Collar
SKU: 1EM-BT-UBA-FD (Color = Red)

1ML EM Traditional Tubing

White (20MM) and Blue (30MM) Draw-Off Caps, Hose 1.8 meter (clear)
SKU: 1EM-FD (Color = Red)

2ML EM Traditional Tubing

White (20MM) and Blue (30MM) Draw-Off Caps. Hose 1.8 meter (clear)
SKU: 2EM-FD (Color = Black)

Syringes available individually or in cases of 25



Multi-Purpose Dosing Instruments

12.5ML, 30ML, 70ML Luer Tip Injector, 5.5" Drencher Nozzle, Pour On Tip

- Automatic self-filling syringe
- Easy set dial-a-dosage with easy view dosage window
- Tips included for Injector, Drencher and Pour On applications
- Removable barrel for cleaning
- Replaceable front valve and spring with lock-in-place feature
- Durable plastic design
- Easy V-grip for high volume use
- Amber colored barrel reduce UV sun light exposure



12.5EM-SDP
(Adjustable dosage from
.5ML to 12.5ML)
SKU: 12.5EM-SDP



30EM-SDP
(Adjustable dosage from
5ML to 30ML)
SKU: 30EM-SDP



70EM-SDP
(Adjustable dosage from
7.5ML to 70ML)
SKU: 70EM-SDP

Nozzles



DF Masterline™ Syringe

Roux Revolver 50ML Syringe

- Proven Pistol Grip Design
- Durable Metal construction with a glass barrel
- High quality for long service life



HSW ECO-MATIC® TWIN



The Market's First Lightweight, Ergonomic Compact Double Barrel Plastic Syringe

- Simultaneous vaccination of two products independently
- Premium quality plastic syringe with durable plastic barrels
- Reusable - The only plastic syringe that can be boiled
- Ergonomic, lightweight design for comfort and ease of use
- Bottle mount and/or tubing connection
- Adjustable barrel orientation for comfort and different bottle sizes



- Unique Patent Pending Needle Nut Swivel Design
- Needle distance can be adapted to the age, size and species of the animal*
Seven different distances:
 20MM - 21.1MM - 22MM - 28MM - 32MM - 34.9MM - 36MM

- Four Fixed Dose Barrel combinations available:

Package Includes:

- Two Universal Bottle Collars (20mm & 30mm)
- Two Universal Spigot Draw-off Collars (4-6mm)
- Two soft PVC tubing

Allflex SKU	Allflex Description
1/1 EM-TWIN	1/1 EM TWIN Syringe With Accessory Pack
2/2 EM-TWIN	2/2 EM TWIN Syringe With Accessory Pack
1/2 EM-TWIN	1/2 EM TWIN Syringe With Accessory Pack
.5/2 EM-TWIN	.5/2 EM TWIN with Accessory Pack

SKU	Description
Twin-B-L-EM.5ML	Twin Barrel Left 0.5ML Universal
Twin-B-L-EM1ML	Twin Barrel Left 1ML Universal
Twin-B-L-EM2ML	Twin Barrel Left 2ML Universal
Twin-B-R-EM.5ML	Twin Barrel Right 0.5ML Universal
Twin-B-R-EM1ML	Twin Barrel Right 1ML Universal
Twin-B-R-EM2ML	Twin Barrel Right 2ML Universal
EM.5ORING	Piston O-ring 0.5ML
EM1ORING	Piston O-ring 1ML
EM2ORING	Piston O-ring 2ML
TWIN FRONT WASHER	Front Sealing Washer Stepped
TWIN FRONT LUER LOCK	Front Part II Hexagonal
TWIN SWIVEL NUT	Twin Swivel Nut



Drenchers



10VM Drencher
 (Adjustable dosage from .5ML to 10ML)
 SKU: 10VM-D

20VM Drencher
 (Adjustable dosage from 1ML to 20ML)
 SKU: 20VM-D

10VM & 20VM Drenchers

- Automatic self-filling tube feed
- Designed to be used as an injector or drencher
- Accurately delivers selected dose
- Easy V-grip for high volume use
- Easy-to-adjust handle tension for improved performance
- Durable metal and plastic design
- Double O-ring Piston
- Easy-to-clean external valves and removable piston shaft
- Amber-colored barrel and tubing reduce UV sunlight exposure

70ML & 200ML Drenchers

- Durable barrel with metal push rod and piston
- Dosage calibrations controlled by distal screw
- Easy-to-use grip



70ml Drencher
 (Adjustable dosage from 10ML to 70ML)
 SKU: UKAL-70ML

200ml Drencher
 (Adjustable dosage from 10ML to 200ML)
 SKU: UKAL-200ML

10ML Nylon Syringe
 (Adjustable dosage from 1ML to 10ML)
 SKU: TU MASTERLINE-10ML

20ML Nylon Syringe
 (Adjustable dosage from 1ML to 20ML)
 SKU: TU MASTERLINE-20ML

50ML Nylon Syringe
 (Adjustable dosage from 5ML to 50ML)
 SKU: TU MASTERLINE-50ML

10ML, 20ML & 50ML Nylon Syringes

- Durable clear Nylon construction with comfort handle
- Metal Luer Lock Tip and Plunger Shaft
- Visible barrel scale with dosage increments
- Fully boilable for disinfection
- Individually packaged including spare O-ring parts
- Available in 10ML, 20ML and 50ML



SKU	Description
TU FLEX-MASTER A 10 ML LL	TU MASTERLINE 10ML SYRINGE
TU FLEX-MASTER A 20 ML LL	TU MASTERLINE 20ML SYRINGE
TU FLEX-MASTER A 50 ML LL	TU MASTERLINE 50ML SYRINGE
TU FLEX-MASTER B 10 ML LL	TU MASTERLINE/DOSAGE LOCK 10ML SYRINGE
TU FLEX-MASTER B 20 ML LL	TU MASTERLINE/DOSAGE LOCK 20ML SYRINGE
TU FLEX-MASTER B 50 ML LL	TU MASTERLINE/DOSAGE LOCK 50ML SYRINGE

ACCESSORIES

SG-Nozzle

SG-Nozzle threads into the Luer Lock Syringe to make a syringe into a drencher for sheep and goats

SKU: SG-NOZZLE



Back Pack

2.5 Liter Back Pack: SKU: BACK25

5 Liter Back Pack: SKU: BACK5L

Back Pack comes with straps



Back Pack

Replacement Back Pack Cap

SKU: BACK-CAP



Draw-Off Color Coded Caps

20MM (white): SKU: HD20W

30MM (blue): SKU: HD30B

33MM (green): SKU: HD33G



Extension Syringe

- Allows for increased distance to breeding animals
- Enhances user safety
- Long lasting strong and durable carbon-metal design
- Heavy metal luer needle lock
- Ergonomic and lightweight
- Optimized for use with Allflex Syringe Line



SKU: SYR-EXT29CM

Injection Bar for Swine

- Allows for increased distance to breeding animals
- Enhances user safety
- Reduce user exposure to crates and gating
- Time saving for mass vaccinations
- Long lasting strong and durable carbon-metal design
- Heavy metal luer needle lock
- Kink protection for tubing
- Ergonomic and lightweight
- Optimized for use with Allflex Syringe Line



SKU: SE17

Bottle Holders

- Constructed of premium quality Neoprene
- Hanging/Belt and Arm models available
- Designed to fit and protect medicine and vaccine bottles
- Prevents or reduces vaccine temperature fluctuations
- Protects glass bottle from outside impact
- Shields vaccine from harmful UV lights
- Easy and comfortable use
- Built in needle holders from convenience
- Three sizes available: Small, Medium and Large



SKU's: HSW-BH-ARM SMALL HSW-BH-BELT SMALL
 HSW-BH-ARM MEDIUM HSW-BH-BELT MEDIUM
 HSW-BH-ARM LARGE HSW-BH-BELT LARGE

PRIMING A SYRINGE

Priming the syringe eliminates air from the system, assuring the proper dose is administered.

- 1 Position the dosage indicator to approximately half the capacity of the cylinder.
- 2 Pump the handle until the medication is expelled from the needle or nozzle in an unbroken stream. To avoid loss of medication during priming, insert sterile needle or nozzle into the neck of the container.

SYRINGE CLEANING & MAINTENANCE

Proper care can extend the life of your Allflex Syringe. After use, or when switching medications, the cylinder and feed tube should be thoroughly cleaned. Note: See Frequently Asked Questions for boiling technique.

- 1 Add 4-5 CC of detergent to one quart of hot water. Note: When using modified live virus vaccines, use caution selecting detergent. Avoid antibacterial/ disinfectant soap as it may harm the vaccine.
- 2 Set the dosage system on maximum and briskly pump the hot detergent solution through the medication reservoir, feed tube and instrument.
- 3 Rinse by pumping clean water through the reservoir, feed tube and instrument until water is expelled.
- 4 Pump dry and remove the tubing.
- 5 To maintain the O-rings and valves, periodically lubricate the syringe with a small amount of castor oil or vegetable oil. Note: Do not use mineral oil, silicone, WD40, glycerin or alcohol. Petroleum-based products harden the rubber rings and valves, reducing the life of the components.

USING A TUBE FED SYRINGE

To attach a medication reservoir:



1

Attach one end of the amber tube to the syringe/drencher



2

Option 1: Attach the other end of the amber tube to the selected draw-off cap



3

Option 2: Attach the other end of the amber tube to the 2.5 liter back pack

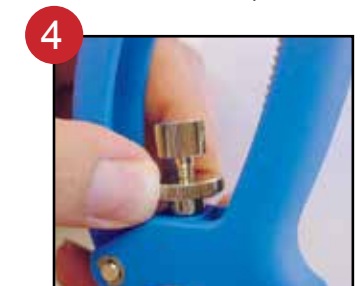

4

Loosen dose adjustment lock nut

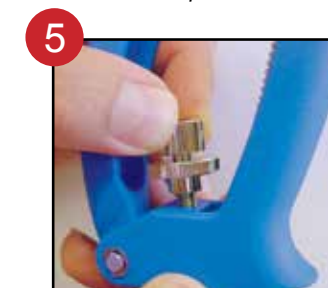

5

Turn dosing adjustment screw to set the required dosage. Retighten lock nut



6

Handle spring pressure can be adjusted for comfort and tension

*** We no longer accept returns on products shipped to swine facilities as part of our biosecurity commitment.**

Recommended Tag Placement

Application site must be free of foreign debris prior to placement of tags on the animal. Review application instruction prior to tagging.

IMPORTANT: Caution, "Free Air Space" is critical for proper healing and retention. Inspect placement after tagging to ensure there is sufficient space between ear and EID tag.

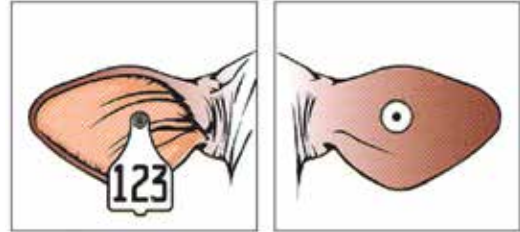

FOR CATTLE

1. The EID tag should be placed in the middle of the ear between the two cartilage ribs close to the head.
2. The female portion of the tag should be on the inside of the ear with EID tag application. Note that this is a thicker part of the ear. Application may be more difficult than when applying a visual tag.

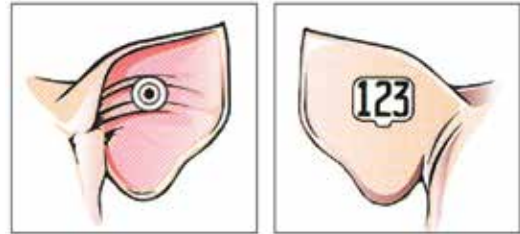

FOR SWINE

1. Place the EID tag in the middle or thicker part of the ear.
2. The male tag should be on the outside of the ear and the female (or EID tag) should be placed on the inside of the ear. Tag retention is improved when male tag lays flush against the back side of the ear.

IMPORTANT: Tag application may vary based on breed type and ear size.

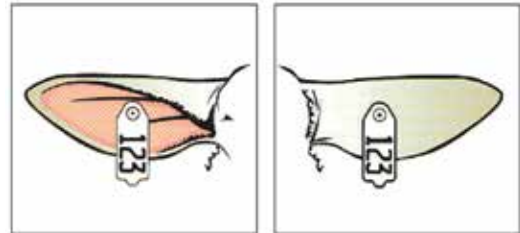

FOR SHEEP

1. Place the EID tag in between the cartilage ribs of the ear, near the first quarter of the ear (closest to the head).
2. The female portion of the tag should be placed on the inside of the ear.



Apply Allflex Electronic ID Tags with the Red Universal Total Tagger. Use the red blunt pin and remove the black insert from the base of the jaws.

Hooking the clip on a metal surface and pulling against it, is the best way to "pop" the clip out of the applicator.



Universal Total Tagger Black Insert
SKU: CLIP-UTT-K
SKU: CLIP-UTT-W
(White clip is for insecticide tags)



Easy Steps Tag/TSU • Lookup User's Guide

Finding Your Tag/TSU Numbers

Step 1. Navigate to www.allflex.global/na and Find "Tag Lookup" at the top of the screen



Step 3. You may also enter **Multiple Bag#s**. Hit <enter> between the bag#s or copy and paste a list from a text or Excel file

Step 4. Click on Lookup

Step 5. The numbers you entered will show green on the grid after you click on Lookup, as shown. You are now ready to download your numbers. You can expand the green rows and see details by clicking on the plus sign. Only rows selected in green will be downloaded.

	Bag#
+	1000029338
+	1000029349
+	1000029350
+	1000029361
+	1000029372
+	1000029383

Step 2. Locate the Master#, Pallet#, Case#, Bag# or Tag# on labels as shown and enter them individually



Enter Master#, Pallet#, Case#, Bag# or Tag# or enter multiple bag numbers.

Master#, Pallet#, Case#, Bag# or Tag#

C1000228330

Multiple Bag #s

1004374780
1004374791
1004374805
1004374816
1004374827

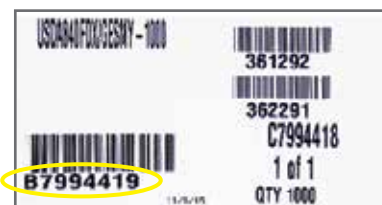

* = Bag(s) Not Found

Master#, Pallet#, Case#, Bag# or Tag#

Multiple Bag #s

Bag(s) Not Found
Bag(s) Not Found are marked with an * in the list. You can fix the entry and re-submit by clicking Lookup and/or proceed with the selection

1000029338
1000029349
1000029359*
1000029361
1000029372



Downloading Your Tag/TSU Numbers

Step 6.

Select the file type and format in which you would like your numbers to be saved.

CSV = Comma Separated Value
XLS = Excel Spreadsheet
XML = Web Document

Select File Type and Format and Click Download

CSV XLS XML

Original

The selected format contains: Bag#, Eid#, Mgmt#, Reg#

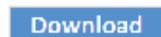

Step 7.

Click download and open or save to your computer

Internet Explorer:

Do you want to open or save VBags_11_5_2015_11_21_52 AM.CSV from allflexlink.com

Chrome:

VBags_11_5_20....C...



Livestock Intelligence™

www.allflex.global/na

Allflex USA, Inc.

2805 E. 14th Street • P.O. Box 612266
Dallas/Fort Worth Airport, TX 75261-2266
(800) 989.TAGS

Allflex Canada

4135 Bérard
St-Hyacinthe, QC J2S 8Z8
(866) 505.TAGS

